



**FORD & DOONAN**  
Air Conditioning Systems

# Operating Instructions

for your Ford & Doonan Ducted System



# Congratulations!

Congratulations on your new Ford & Doonan Air Conditioning System. You can rest assured you have received a system of the highest quality, backed by the very best customer service. Before operating the air conditioner, please read this operating manual carefully. It will advise you on how to operate the unit correctly, understand the air conditioner's advanced features and help you in the unlikely event that a problem should occur.

Please keep this manual in a safe place for future reference.

**Thank you**  
for purchasing  
Ford & Doonan  
Air Conditioning



**FORD & DOONAN**  
Air Conditioning Systems



# Contents

1. Important Safety Instructions .....	4
2. Zone Operation.....	5
3. Outlets.....	6
4. Maintenance.....	7
5. Common Queries.....	8
6. Performance Expectations .....	9
7. Performance Tips.....	10-11



Scan to view our Operation Videos on our website or visit [fordanddoonan.com.au/operation-videos-and-manuals](http://fordanddoonan.com.au/operation-videos-and-manuals)

# 1. Important Safety Instructions

Never remove any fixed covers on the indoor or outdoor unit. Removal of the covers may expose fast moving fan blades or electrical components operating at a hazardous voltage. Contact with the blades or high voltage components may result in injury or electric shock.

Never insert any objects into the openings of the indoor or outdoor unit. This may damage the product or result in injury to the person inserting the object.

Do not expose the indoor unit or remote controller to rain or moisture. Water or other fluids on the electrical components may result in fire or electric shock.

Always replace any blown fuse with a fuse of the same specification. The use of the

wrong fuse may allow the electrical wiring to overheat and catch on fire. If the correct type of fuse continues to blow, or the circuit breaker continues to trip, contact Ford & Doonan Service Department.

Never operate the air conditioner without the return air filter(s) in place. Operating the unit without the filter(s) will allow dust to enter the indoor unit and build up on the heat exchanger coil and fan motor. This will cause a malfunction of the unit, which will not be covered by warranty.

This electrical appliance is not intended for use by young children. Young children should be supervised to ensure that they do not play with the outdoor unit.



## Main switch

Ensure you are familiar with the location of the main switches for the air conditioning system. These switches are normally located adjacent to the outdoor unit and in the fuse box/switchboard.

If the air conditioner is not going to be used for an extended period of time or you are going away on holidays, the main

switch should be turned off to prevent accidental operation of the air conditioner. When turning the system back on, the main switch must be turned on at least 6 hours before the air conditioner is operated to warm up the compressor. Failure to do so may result in damage to the compressor, which will not be covered by warranty.

## 2. Zone Operation

### Applicable when your new system has zones fitted

- For operational instructions please refer to the attached sub manual (if applicable).
- It is possible to run all zones at the same time, however, the system will not be running very efficiently.
- You may operate two or more zones at once, depending on the capacity of your unit, design and heat load. For example, under maximum heat load (a hot day) it is better to have fewer zones on than under a low heat load (at night) when an extra zone may be turned on.
- We recommend turning on the living areas during the day and closing any bedrooms and other zones that are not needed. At night it is best to turn off any living areas and keep the bedroom zones open. This will allow the best efficiency of the system.
- The zones can take up to 2 minutes to open or close.
- If some zones do not have enough air flow check how many zones are open. Close off any zones that are not needed and see if air flow increases.



# 3. Outlets

## Multi-Directional outlets

Multi-Directional outlets (if applicable) are designed to give maximum adjustment to airflow. Each of the four cores (called louvre panels) is adjustable by lifting and turning to direct air from one direction to another. For the distribution of cool air, the louvre panels are set to deflect air horizontally across the ceiling. For high ceilings and heating systems the louvre panels are adjusted to achieve 40% downward flow. For spot cooling and heating, the louvre panels oppose each other for a vertical down airflow. The outlets can be manually closed during winter if the

system is not used for heating, although this is not a necessity.

## Sidewall registers

Sidewall registers (if applicable) have vertical and horizontal blades that are adjustable. The blades are manufactured not to rattle. Any adjustments are required to be done with the assistance of long nose pliers with insulation tape wrapped around the ends so the paint of the register is not damaged. Gently move the blades to the desired position.

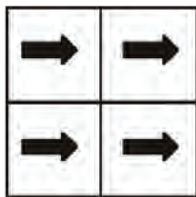

**ONE WAY**

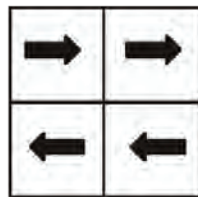

**TWO WAY**

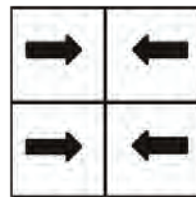

**TWO WAY**

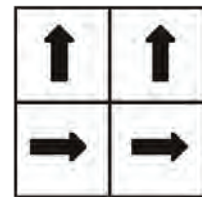

**TWO WAY**

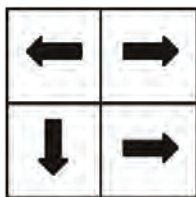

**THREE WAY**

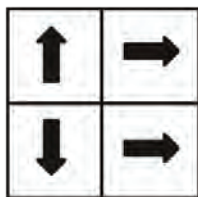

**THREE WAY**

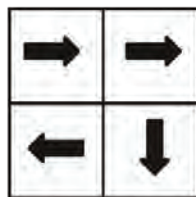

**THREE WAY**

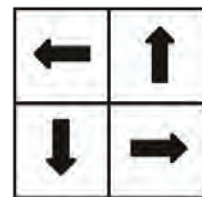

**FOUR WAY**



# 4. Maintenance

## 1. Cleaning the air filter

If you have a clean air filter pack, please call your Ford & Doonan store to purchase a replacement filter. We recommend replacing the filter every 12 months, if you have allergies or pets, we recommend replacing the filter every 6 months.

To clean your filter, remove the filter, hose it down and leave it a couple of hours to dry. Once this is done do not forget to press the filter reset button on your air conditioning controller.

## 2. Cleaning the outside panel

Cleaning of the outside panel is easy, by using a soft cloth or a cloth dampened by a neutral detergent solution. Never use paint thinner, other chemical products, or polishing powder when cleaning the outside panel. A good quality car polish can be applied to the painted surfaces to increase the paint's durability.

## 3. When the unit is not being used for an extended period

- Switch off the main power switch.

- Rust preventative coating has been applied to the outside cover. If corroded, repair by painting.
- Clean the condenser to remove dust and excess waste (leaves, paper, etc.).

## 4. Maintenance service contract recommended

To ensure your system delivers cool, fresh air throughout the year and that your warranty is valid, it's essential you maintain it regularly. Preventative maintenance by qualified technicians has been proven to reduce the risk of failure of plant and equipment and maintain the efficiency of the overall installation.

Servicing by a qualified Ford & Doonan technician is recommended. For domestic operation of the air conditioning system we recommend an annual service. If equipment is subjected to heavy use a bi-annual service frequency is desirable.

Contact your Service Department (9331 8800) to set up automatic service reminders and ask about our three year service packages at a reduced cost.

We recommend replacing your disposable filter every 12 months



DISPOSABLE filter

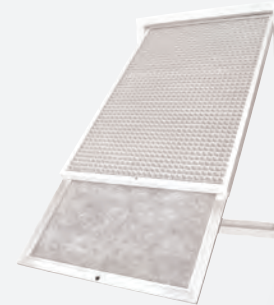

WASHABLE filter

# 5. Common Queries

**If the air conditioning is not running or the cooling effect cannot be achieved as desired, check the following points before requesting repair or service.**

If the air conditioner does not function please check the following:

Is the power switched ON?

Has the power fuse failed?

Is power supplied?

Has the circuit breaker tripped?

Is the temperature indicator set in the correct operating position, or to a position which is too high for the cooling operation?

## **How to perform a reboot of your air conditioning system**

Before calling the Service Department please perform a reset of your air conditioning system. As any electrical appliance, power dropouts or surges can interrupt the operation of the system. In most cases a reboot is all that is required. In case the system has never been used before, make sure that the main switch has been turned on for at least 6 hours before using the air conditioning unit.

Locate the isolator switch at the outdoor unit. It is a big white switch at the outdoor unit. Turn it off and wait 3 minutes before turning it back on.

If the system does not reboot, or the fault still appears please call the Ford & Doonan Service Department.

## **Not cooling or heating as desired please check the following:**

Is the thermostat set to the proper position to heating or cooling?

Is there an obstruction near the air intake or outlet port?

Is the air filter free from clogging by dust, dirt, etc.?

Are doors and windows completely closed?

## **Smoke coming from outdoor unit?**

In cold weather you may see what appears to be smoke coming from the unit. This is just steam being released when the unit is in de-ice mode. Further you may notice the unit icing up and appearing frozen. This is normal as long as the system completes a de-ice cycle.

## **“Filter clean” displays**

If a small tap or spanner symbol appears, this indicates it is time to clean or replace the filter. Press this switch to reset and clear the symbol once you have cleaned or replaced the filter. Please see Maintenance for more information on how to clean your filter. If the spanner symbol appears with a fault code, it is advising you of a problem and you will need to contact your Service Department.

## **Faults:**

If the **“CHECK”** indicator starts flashing, this means there is a fault at hand.

In this case, or if fault codes appear, please call your Service Department with the fault code, explain the problem and they will be able to assist with the issue.



## 6. Performance Expectations

### Hot weather

Heat load calculations and manufacturers capacity ratings are based on an outside temperature of 36°C. When the temperature exceeds this, the performance of your air conditioner will fall away the hotter it gets and room temperatures will increase accordingly.

### Cold weather

Heat load calculations and manufacturers capacity ratings are based on an outside temperature of 7°C. When the temperature is lower than this, the performance of your air conditioner will fall away the colder it gets and room temperatures will decrease accordingly. The above conditions do occur in Perth and there will be nothing wrong with your air conditioning unit when it happens.

### Heating performance

Hot air rises and the room temperatures at different levels will be different. It is normal that some parts of the room will be warmer than others. The same applies on cooling mode but to a lesser degree.

### Return air

Your system will usually be designed with one only return air grille. The area around the return air grille will always be drafty, and in Winter, always much cooler than the rooms. This is why we select hallways or other “non occupied rooms”. You will have to leave any room’s entry door ajar to allow the conditioned air to come back to the grille. You cannot close the door as performance will be affected. We have options to overcome these situations, so please discuss this with your consultant.

### Zones

If we have installed zones, then they cannot all be turned on together without effecting performance. On low load days or nights your air conditioner can handle a larger area at one time. Your air conditioner can only handle the percentage of the home we mention in our letter at typical design temperatures. Turning on less zones will effectively increase the available capacity you have.



# 7. Performance Tips

## 1. Temperature setting on your air conditioning unit

We recommend that in summer you set the cooling cycle at 24 degrees and in Winter the heating at 21 degrees. On very hot days (above 36 degrees) or cold days (below 7 degrees) one can increase the temperature in Summer and decrease in Winter, to keep the efficiency of the air conditioning.

## 2. To keep the comfortable temperature without extra heat loading

The easiest solution to start your air conditioner earlier in the day by using your timer setting. On hot days start the air conditioner before your heat load increases so the air conditioner can get a head start. On cold days start the air conditioner whilst it is still warm outside (above 12-15°C). This will let the air conditioner deliver maximum capacity before performance falls away. If your system has zones (residential only) reduce the number of zones turned

on when the external conditions are extreme. The smaller the area being air conditioned, the better it can cope.

## 3. Close doors of rooms that are not being air conditioned

When operating an air conditioning system that utilises the zoning technique, remember the system has only a certain capacity, therefore the idea is to air condition the areas you are occupying at the time. With this in mind, it becomes prudent to habitually close the doors that lead to a non air conditioned area, thereby reducing the total area being subjected to air conditioning. This will enhance the effectiveness of the machine.

## 4. Allow air flow to return air grille

You will notice that the larger return air grill is normally located in a central position in the building. It is important to encourage the airflow towards this grille. This grille is drawing the total air capacity of the system through it and therefore



requires unrestricted airflow. Depending upon the building, you may need to open or close doors around this area to keep the air flowing to this grille.

## 5. Regular cleaning of the filter is important

The return air grille in most cases also contains an air filter. This air filter, depending on the system usage and other air quality factors, will need to be cleaned regularly. To do this, simply open the grille and slide out the filter. In most cases it is best to hose the filter clean, although some people prefer to vacuum the filter. Remember, regular cleaning of the filter will improve the system efficiency.

## 6. Clean outdoor unit and surroundings

The condensing or outdoor unit is located in a position to best suit the building and the occupants. It is important to maintain cleanliness around the unit, for example sweeping away any build-up of leaves or general flotsam. It is critical to not inhibit the airflow coming from the condenser, therefore general garden paraphernalia or other equipment should never be

stacked on or lent against the condenser. Similarly if a garden is developing around the condenser, this can be an advantage as some of the sound from the condensing unit will be absorbed, although a robust bush can block the air flow so consideration should be given to this. It is also imperative to keep the condensing unit accessible for servicing purposes.

## 7. Sizing of equipment

When we recommend a unit we have completed a heat load calculation on the area. We have assumed the following:

- Curtains will be drawn closed in both sunny Summer days and at night in Winter.
- Ceiling insulation has been installed directly above your ceiling (not just anti-con or sisalation)
- Doors and windows will be left closed.

If any of the above changes, your air conditioner may not be large enough to maintain acceptable room temperatures.

# WIRED REMOTE CONTROLLER

## OPERATION MANUAL



BRC1E63

- Thank you for purchasing this product.
- This manual describes safety precautions required for the use of the product.

**Read this manual carefully and be sure you understand the information before using the product.**

Keep this manual where it is readily accessible after reading it through. If another user operates the product in the future, be sure to hand over this manual to the new user.

Refer to the operation manuals attached to the indoor and outdoor units, etc.

# Contents

## Notices

Safety Precautions	
– Items to be Strictly Observed – .....	2
Button Location and Descriptions.....	5
Names and Functions.....	7

## Basic Operation (Use of Direct Buttons)

Cool/Heat/Auto/Fan Operation .....	10
Dry Operation .....	14
Setback.....	16
Ventilation Operation .....	17
Setting the Cool/Heat Selection Eligibility.....	18
Key Lock .....	20

## Quick Reference Main Menu

Main Menu Items .....	21
-----------------------	----

## Menu Manipulation

Manipulating the Main Menu Screen .....	25
Circulation Airflow .....	26
Individual Air Direction.....	27
Quick Start (SPLIT system only) .....	30
Ventilation .....	32
Energy Saving Options.....	34
Schedule.....	43
Filter Auto Clean.....	49
Maintenance Information .....	50
Configuration .....	51
Current Settings.....	59
Clock & Calendar.....	60
Language.....	64

## Maintenance

Reset Filter Indicator .....	65
Cleaning of Remote Controller .....	66

## Reference Information



Malfunction (Error) Code Display .....	67
After-sales Service .....	68

# Safety Precautions – Items to be Strictly Observed –

This product is not intended for use by children or infirm persons without supervision. Children should be supervised to ensure that they do not play with the product.

**Read the safety precautions carefully for the proper use of the product.**

- This manual classifies the precautions into WARNINGS and CAUTIONS. Be sure to follow all the precautions below: They are all important for ensuring safety.

 <b>WARNING</b>	Indicates a potentially hazardous situation which, if not avoided, could result in death or serious injury.
 <b>CAUTION</b>	Indicates a potentially hazardous situation which, if not avoided, may result in minor or moderate injury. It may also be used to alert against unsafe practices.

## **WARNING**

- **Do not install the remote controller by yourself.**  
Improper installation may result in electric shocks or a fire.  
Consult your local dealer.
- **Do not modify or repair the remote controller.**  
It may result in electric shocks or a fire.  
Consult your local dealer.
- **Do not relocate or reinstall the remote controller by yourself.**  
Improper installation may result in electric shocks or a fire.  
Consult your local dealer.
- **Do not use flammable materials such as hairspray or insecticide near the product.**  
It may result in electric shocks or a fire.
- **Do not wipe the product with benzene, thinner, chemical dustcloth, etc.**  
The product may get discolored or the coating peeled off.  
The use of organic solvents may cause cracking of the product, electric shocks or a fire.



## CAUTION

- **Do not allow children to play with the remote controller.**

Accidental operation by children may result in health impairment.

- **Do not disassemble the product.**

Touching the interior parts may result in electric shocks or a fire.  
Consult your local dealer for internal inspections and adjustments.

- **Do not press the button of the remote controller with a hard, pointed object.**

The remote controller may be damaged.

- **Do not pull or twist the electric wire of the remote controller.**

It may cause the unit to malfunction.

- **Do not operate with wet hands to avoid electric shocks or a fire.**

- **Do not wash the remote controller.**

It may cause electric leakage and result in electric shocks or a fire.

- **Do not locate the remote controller wherever there is a risk of wetting.**

If water gets into the remote controller there is a risk of electric leakage and damage to electronic components.

It may result in electric shocks or a fire.



## ■ Disposal requirements

Your product and the batteries supplied with the controller are marked with this symbol. This symbol means that electrical and electronic products and batteries shall not be mixed with unsorted household waste.

For batteries, a chemical symbol can be printed beneath the symbol. This chemical symbol means that the battery contains a heavy metal above a certain concentration.

Possible chemical symbols are:

■ Pb: lead (>0.004%)

Do not try to dismantle the system yourself: the dismantling of the product, treatment of the refrigerant, of oil and of other parts must be done by a qualified installer in accordance with relevant local and national legislation. Units and waste batteries must be treated at a specialized treatment facility for re-use, recycling and recovery.

By ensuring correct disposal, you will help to prevent potential negative consequences for the environment and human health.

Please contact the installer or local authority for more information.



# Button Location and Descriptions

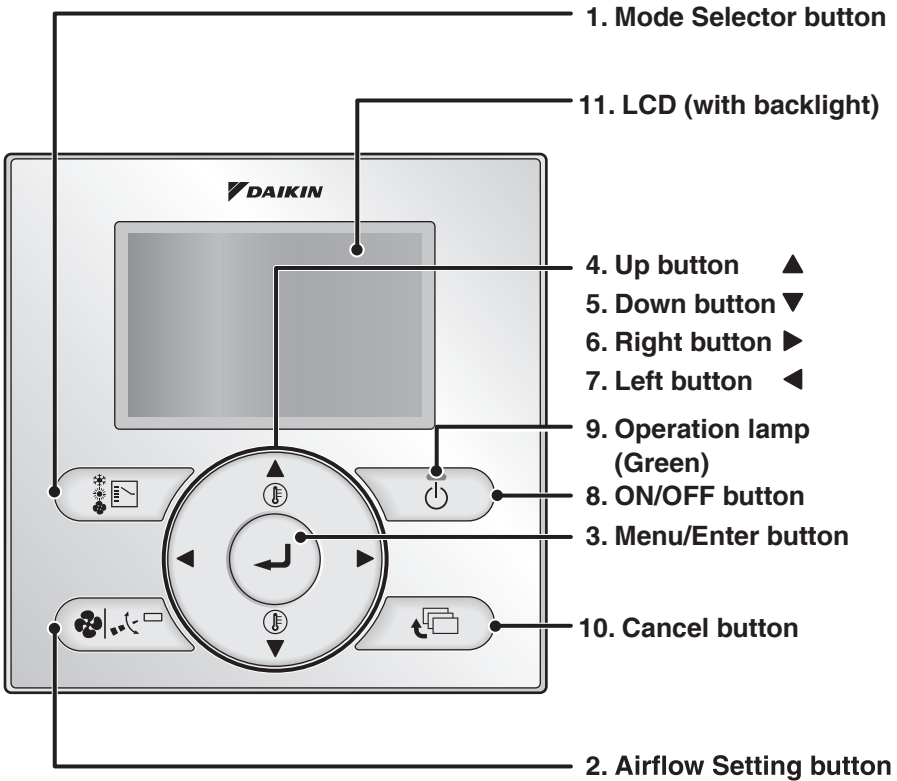

Basic operations (i.e., ON/OFF, Operation Mode, Airflow Rate (Airflow level/Fan Speed), Airflow Direction and Set Temperature) are manipulable directly by the above button.

Advanced settings are manipulable from the Menu screen displayed by the Menu/Enter button.

## NOTE

- Do not press the buttons on the remote controller with a hard, pointed objects. Otherwise, the remote controller may be damaged or malfunction.

## 1. Mode Selector button

---

- Use to select the operation mode of your preference. **(Refer to page 10.)**  
\* Available modes vary with the connecting model.

## 2. Airflow Setting button

---

- Used to indicate the Airflow Rate (Airflow level/Fan Speed)/Airflow Direction screen. **(Refer to page 11.)**  
\* Available fan speed and airflow direction vary with the connecting model.

## 3. Menu/Enter button

---

- Used to indicate the Main Menu. **(Refer to page 21 for the menu items.)**
- Used to enter the setting item selected.

## 4. Up button “▲”

---

- Used to raise the set temperature.
- Use to highlight the item above the current selection.  
(The highlighted items will be scrolled continuously when the button is kept pressed.)
- Used to change the item selected.  
\* Be sure to press the part with the symbol “▲”

## 5. Down button “▼”

---

- Used to lower the set temperature.
- Use to highlight the item below the current selection.  
(The highlighted items will be scrolled continuously when the button is kept pressed.)
- Used to change the item selected.  
\* Be sure to press the part with the symbol “▼”

## 6. Right button “▶”

---

- Used to highlight the next items on the right-hand side.
- Display contents are changed to next screen per page.  
\* Be sure to press the part with the symbol “▶”

## 7. Left button “◀”

---

- Used to highlight the next items on the left-hand side.
- Display contents are changed to previous screen per page.  
\* Be sure to press the part with the symbol “◀”

## 8. ON/OFF button

---

- Press this button and system will start.
- Press this button again and system will stop.

## 9. Operation lamp (Green)

---

- This lamp lights up during operation.
- This lamp blinks if a malfunction occurs.

## 10. Cancel button

---

- Used to return to the previous screen.

## 11. LCD (with backlight)

---

- The backlight will be lit for approximately 30 seconds by pressing any operation button. Press the button while the backlight is lit. (Excluding the ON/OFF button)
- If 2 remote controllers are used to control a single indoor unit, the backlight of the remote controller accessed first will be lit.

# Names and Functions

## Basic Screen

- Basic screen are two types of Standard display screen and Detailed display screen. The Standard display screen is set by default.
- To switch to the Detailed display, select the “Detailed” in the Main Menu. (Refer to page 56.)
- The contents on the screen vary with the operation mode of the connecting model. (The following display will appear when the air conditioner is in Automatic operation.)

### Standard display screen

11. Changeover Under Control

10. Centralized Control

1. Operation mode: Auto

3. Airflow Direction (Displayed only when the air conditioner is in operation.)

2. Airflow Rate (Airflow level/Fan Speed)

7. Ventilation/Air purifying

12. Setback

9. Timer Enabled

8. Key Locked

4. Set/Setback Temperature display

5. Defrost/Hot start

6. Message: This function not available

<Standard display example>

### Detailed display screen

- The clock, and selectable display items appear on the detailed display screen in addition to the items appearing on the standard display screen.

13. Clock (12/24 hours time display): Fri 11:03

4. Set/Setback Temperature display: Cool 35°C, Heat 10°C, Room 20°C

14. Selectable Display Item (with room temperature selected)

<Detailed display example 1>

2. Airflow Rate (Airflow level/Fan Speed) is not appear (No airflow rate control function)

3. Airflow Direction is not appear (No airflow direction function)

13. Clock (No clock setting)

15. Timer Disabled/Reset Clock

14. Selectable Display Item (No selectable display item selected)

<Detailed display example 2>

## 1. Operation Mode

---

- Displays the present operation mode, “Cool”, “Heat”, “Vent”, “Fan”, “Dry” or “Auto”.

## 2. Airflow Rate (Airflow level/ Fan Speed)

---

- Displays the airflow rate that is set for the indoor unit.
- The airflow rate will not be displayed if the indoor unit does not have airflow rate control function.

## 3. Airflow Direction “”

---

- Displayed when the airflow direction and swing are set (Refer to page 12).
- This icon is not displayed if the indoor unit does not have a function to set airflow directions.

## 4. Set/Setback Temperature display

---

- When the air conditioner is turned on, “Set to” indicates the set temperatures that are set for the air conditioner.
- When the air conditioner is turned off, “Setback” indicates the setback temperatures that are set for the air conditioner.

## 5. Defrost/Hot start “” (Refer to page 13.)

---

Displays if the Defrost/Hot start operation is active. If ventilating operation “” is displayed:

- Displayed when a Heat Reclaim Ventilator is connected.  
For details, refer to the Operation Manual of the Heat Reclaim Ventilator.

## 6. Message

---

The following messages are displayed.

“This function not available.”

- Displayed for a few seconds when an operation button is pressed and the indoor unit does not have the corresponding function.

- If a number of indoor units are in operation, the message will appear only if none of the indoor units is provided with the corresponding function, i.e., the message will not appear if at least one of the indoor units is provided with the corresponding function.

“Error: Push Menu button”

“Warning: Push Menu button”

- Displayed if an error or warning is detected (Refer to page 67).

“Quick Start” (Split system only)

- Displayed if the quick cooling/heating function is turned on (Refer to page 30).

“Time to clean filter”



“Time to clean element”

“Time to clean filter and element”

- Displayed when the time to clean the filter or element has come (Refer to page 65).

## 7. Ventilation/Air Purifying

---

- Displayed when a Heat Reclaim Ventilator is connected.
- **Ventilation Mode icon.** “”  
These icons indicate the current ventilation mode (Heat Reclaim Ventilator only) (AUTOMATIC, ENERGY RECLAIM VENTILATION, BYPASS).
- **Air purifying icon** “”  
This icon indicates that the Air Purifying unit (optional accessory) is in operation.

## 8. Key Locked “” (Refer to page 20.)

---

- Displayed when the key lock is set.

## 9. Timer Enabled “” (Refer to page 40 and 48.)

---

- Displayed if the Schedule timer or OFF timer is enabled.

## 10. Centralized Control “”

---

- Displayed if the system is under the management of centralized control equipment (optional accessories) and the operation of the system through the remote controller is prohibited.

## 11. Changeover Under Control “”

---

(VRV only)

- Displayed if the remote controller has no cool/heat selection eligibility. (Refer to page 18).

## 12. Setback “” (Refer to page 16.)

---

- The setback icon blinks when the air conditioner is turned on under the setback control.

## 13. Clock (12/24 hours time display)

---

- Displayed when the clock is set (Refer to page 60).
- If the clock is not set, “-- : --” will be displayed.

## 14. Selectable Display Item

---

- Displayed when the detailed display is selected (Refer to page 56).
- No detailed items are selected by default.

## 15. Timer Disabled/Reset Clock “”

---

- Displayed when the clock needs to be reset.
- The schedule timer function will not work unless the clock is reset.

# Basic Operation (Use of Direct Buttons)

## How to follow the operation manual

### Operation screen display

Describes screens that will be displayed on the remote controller.

1

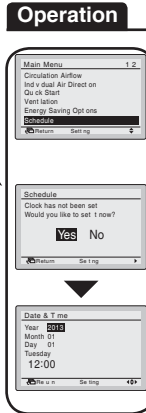

### Operation procedure

Explains a button operation procedure.

- Display the Main Menu screen. (Refer to page 25.)
- Press "▼▲" buttons to select **Schedule**. Press Menu/Enter button to display the Schedule screen.
- Before setting the schedule, the clock must be set.
- If the clock has not been set, a screen like the one on the left will appear.
- Press "◀▶" buttons to select **Yes** and press Menu/Enter button.
- The Date & Time screen will appear.
- Set the current year, month, day, and time. (Refer to "Clock & Calendar" on page 60)

### Operation button

Describes the positions of buttons to be pressed.

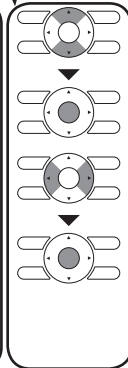

## Cool/Heat/Auto/Fan Operation

### Preparation

- For mechanical protection purposes, turn on the power to the air conditioner at least 6 hours before starting the operation.

### Operation

1

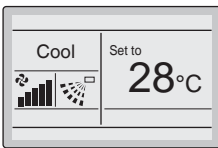

Basic screen

- Press Mode Selector button several times until the desired mode, Cool, Heat, Fan or Auto is selected.



- \* Unavailable operation modes are not displayed.
- \* Only the Cool or Fan mode can be selected if the air conditioner is a cooling only model.

### Note

- The cooling or heating mode cannot be selected if the icon "☒" (Changeover Under Control) is displayed on the remote controller. Refer to page 18 if the icon "☒" display blinks.

2



- Press ON/OFF button.  
The Operation lamp (green) will be lit and the system will start operating.



3

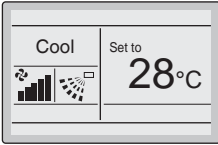

- The set temperature will increase by 1°C when “▲” button is pressed and decrease by 1°C when “▼” button is pressed.

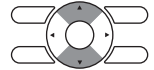

\* No temperature settings are possible while operating in Fan mode.

4

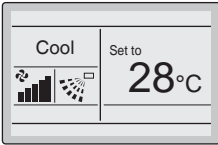

< Airflow Rate (Airflow level/Fan Speed) or Airflow Direction Setting >

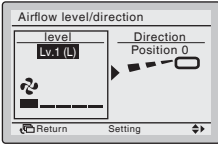

- Press Airflow setting button.
- To select Air volume or Direction setting, press “◀▶” buttons.



5

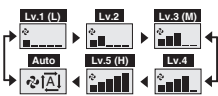

<Airflow Rate Adjustment>

- With level selected, set the desired airflow rate from **Lv.1 (L)**, **Lv.2**, **Lv.3 (M)**, **Lv.4**, **Lv.5 (H)** or **Auto** using the “▼▲” buttons.

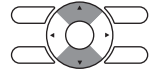

\* Depending on the type of indoor unit, the adjustment levels may be two levels of **Lv.2** and **Lv.4** or three levels of **Lv.2**, **Lv.3 (M)**, and **Lv.4**, or five levels of **Lv.1 (L)**, **Lv.2**, **Lv.3 (M)**, **Lv.4**, and **Lv.5 (H)**

\* For equipment protection purposes, the indoor unit may control airflow rate automatically.

\* According to the room temperature, the indoor unit may control airflow rate automatically.

The fan may stop operating, which, however, is not a failure.

\* It may take time until a change of the airflow rate is completed.

\* In **Auto** setting, the airflow rate is adjusted automatically according to set temperature and room temperature. In Fan mode, the airflow rate setting is always at Lv.5 (H).

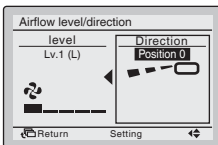

### <Airflow Direction Setting>



- With Direction, selected, set the desired airflow direction from, **Position 0**, **Position 1**, **Position 2**, **Position 3**, **Position 4**, **Swing**, and **Auto** using the “▼▲” buttons.

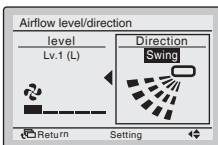

Airflow direction setting (up/down)

#### Note

- Airflow direction appears on the screen as below.



Up/down direction

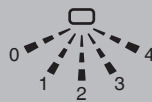

Left/right direction

- 0 : Position 0
- 1 : Position 1
- 2 : Position 2
- 3 : Position 3
- 4 : Position 4

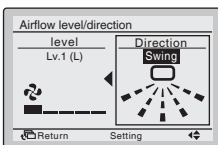

Airflow direction setting (left/right)

- When you set one of positions 0 to 4, the airflow direction flap stay in a fixed position.
- Selecting **Swing** will cause the airflow direction flap to swing position 0 to 4. For the swing setting only, all positions will be displayed.
- Setting **Auto** will varied airflow direction by room temperature and the presence or absence of the person. However, in Fan mode, the airflow direction flap will be to position 0. (This function may not be available depending on the type of indoor unit.)

- Press Menu/Enter button to confirm the settings and return to the Basic screen.



## Movement of airflow direction flap (blade)

Under the operation conditions shown below, airflow direction is controlled automatically. Actual operation may thus be different from what is displayed on the remote controller.

### Operation condition

- Room temperature is higher than the set temperature (in Heat/Auto mode). (Discharge horizontally so that it does not discharge directly toward your body.)
- When the air conditioner goes into Heating Operation or Defrost Operation (in Heat/Auto mode). (Discharges horizontally to avoid a cold draft for the room occupants.)
- Under continuous operation with the airflow discharges horizontally (in Cool/Auto mode). (Discharges in the automatic set direction for a period of time to prevent condensation on the horizontal flap.)
- Under continuous operation with the airflow discharges downward (in Cool/Auto mode). (Discharges in the automatic set direction for a period of time to prevent condensation on the horizontal flap.)



# 6



- When the ON/OFF button is pressed again, the air conditioner will stop operating and the Operation lamp will turn off.



- \* When the air conditioner is stopped while in the Heating Operation, the fan will continue to operate for approximately 1 minute to remove residual heat from the indoor unit.

### Note

- To prevent water leakage or system failure, do not turn off the power immediately. Wait at least 5 minutes for the drain pump to finish draining residual water from the indoor unit.

## Characteristic of Cooling Operation (in Cool/Auto mode)

- When operating continuously at horizontally or downward airflow direction, air blows in the automatically set direction for a period of time to prevent condensation on the horizontal flap.  
(The remote controller displays the airflow direction that is set.)
- If the Cooling Operation is used when the room temperature is low, frost forms on the heat exchanger of the indoor unit. This can decrease the cooling capacity. In this case, the air conditioner automatically switches to the Defrost Operation for a while. During the Defrost Operation, the low airflow rate or a gentle wind is used to prevent the discharge of melt water.  
(The remote controller displays the airflow rate that is set.)
- When the outdoor air temperature is high, it takes some time until the room temperature reaches the set temperature.

## Characteristics of Heating Operation (in Heat/Auto mode)

### Starting Operation

- Heating Operation generally requires a longer time to reach the set temperature compared with Cooling Operation. It is recommended to start operating in advance by utilizing the timer.

**The air conditioner automatically controls the following operation to prevent the reduction of heating capacity and space comfort.**

### Defrost Operation (Frost removal operation for the outdoor unit)

- The air conditioner will automatically go into Defrost Operation to prevent frost accumulation at the outdoor unit and loss of heating capacity.
- The indoor unit fan will stop, and “❄️/🔥❄️” (Defrost/Hot start) will be displayed on the remote controller.
- The air conditioner will return to normal operation after approximately 6 to 8 minutes (Max 10 minutes).

### Hot start

- When the air conditioner goes into Heating Operation or Defrost Operation, the indoor unit fan will stop in order to prevent a cold draft. (In that case, “❄️/🔥❄️” (Defrost/Hot start) will be displayed on the remote controller.)

## Regarding outdoor air temperature and heating capacity

- The heating capacity will drop with a decrease in outdoor air temperature.  
If the heating effect is insufficient, it is recommended to use another heating appliance in combination with the air conditioner.  
(When a combustion appliance is used, ventilate the room regularly.)  
Do not use the combustion appliance in places where the combustion appliance is exposed to the wind from the air conditioner.
- This air conditioner is a hot air circulation type to warm the whole room. Therefore, it takes some time for the room to become warm after the system starts operating.  
When the room temperature exceeds the set temperature, the indoor unit discharges a gentle breeze (switches to gentle wind). The airflow direction becomes horizontal.  
(The remote controller displays the airflow rate and airflow direction that are set.)
- If the hot air stays around the ceiling and your feet feel cold, the use of a circulator is recommended.  
For details, consult your local dealer.

## Dry Operation

### Preparation

- For mechanical protection purposes, turn on the power to the air conditioner at least 6 hours before starting the operation.
- Dry mode may not be selected if the remote controller has no eligibility to select cooling/heating mode (Refer to page 19 for details).

### Operation

1

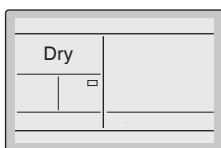

- Press Mode Selector button several times until Dry mode is selected.



- \* Dry mode may not be available depending on the type of indoor unit.

2



- Press ON/OFF button.  
The Operation lamp (green) will be lit and the air conditioner will start operating.



- \* The air conditioner controls temperature and airflow rate automatically. Therefore, set temperature or airflow rate settings are not available while the air conditioner is in operation.

---

# 3

- To set airflow direction refer to page 11.

---

# 4



- When ON/OFF button is pressed again, the air conditioner will stop operating and the Operation lamp will be turned off.



### Note

- To prevent water leakage or system failure, do not turn off the power immediately. Wait at least 5 minutes for the drain pump to finish draining residual water from the indoor unit.

## Characteristics of Dry Operation

Dry mode repeats the weak cooling operation intermittently to dehumidify the room without dropping the room temperature as much as possible for the prevention of excessive cooling.

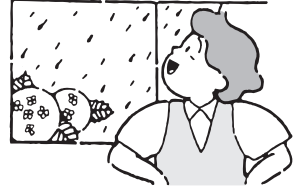

## Setback

The Setback function will maintain the room temperature in a specific range during unoccupied periods.

### Note

- This function will temporarily start an air conditioner that was previously turned off by the user or turned off from a schedule setting/off timer.
- This function is disabled by default. This function can be changed enable/disable by Main Menu. (Refer to page 34)

For example:

Setback temperature: cool 35°C, Heat 10°C
Recovery Differential: cool -2°C, Heat +2°C

- If the room temperature drops below 10°C, the air conditioner starts operating in Heating automatically. As soon as it reaches 12°C, the air conditioner returns to its original status.
- If the room temperature goes above 35°C, the air conditioner starts operating in Cooling automatically. As soon as it reaches 33°C, the air conditioner returns to its original status.

The differential can be adjusted in the Setback condition menu (Refer to page 36).

The setback temperature can be set on Basic screen during the air conditioner is turned off. Or the setback temperature can be set in the schedule (Refer to page 46).

**Operation** The setback cannot be enabled when a centralized control equipment is connected.

1

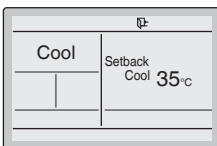

The Setback icon "🏠+" blinks when the air conditioner is turned on under the Setback control.

# Ventilation Operation When Air Conditioner Interlocked with Heat Reclaim Ventilator

## Preparation

- For equipment protection purposes, turn on the power to the air conditioner at least 6 hours before starting the operation.

## Operation

1

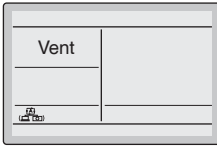

- Press Mode Selector button several times until Vent mode is selected.



- \* Vent mode is for single operation of Heat Reclaim Ventilator for the season when cooling/heating is unnecessary.

2

- The Ventilation mode can be changed from the Main Menu. (Refer to page 33).

- \* Ventilation mode: Auto, Energy Reclaim Ventilation and Bypass

3

- The Ventilation rate can be changed from the Main Menu. (Refer to page 32).

- \* Ventilation rate: Low or High

4



- Press ON/OFF button. The Operation lamp (green) will be lit and the Heat Reclaim Ventilator will start operating.



5



- When ON/OFF button is pressed again, the Heat Reclaim Ventilator will stop operating and the Operation lamp will be turned off.



# Setting the Cool/Heat Selection Eligibility

(VRV only)

Refer to “Cool/Heat Selection Eligibility” on page 19 for an explanation of the cool/heat selection eligibility.

## Setting Changes

1

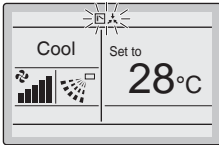
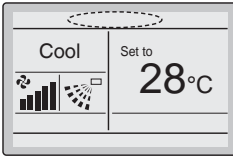

- Press Mode Selector button on the remote controller that has cool/heat selection eligibility for at least 4 seconds. (During backlight lit)  
A remote controller will not display “” (Changeover Under Control) if a cool/heat selection eligibility is granted to the remote controller.



- The icon “” on each remote controller of indoor units connected to the same outdoor unit or BS unit will start blinking.

- \* Vent mode setting changes are possible regardless of the cool/heat selection eligibility.
- \* If a cool/heat selection eligibility is set in the “Cool/Heat selector” (★), all the remote controllers will display the icon “”. In this case, no cool/heat selection eligibility can be set in the remote controllers.
- ★Refer to the Operation Manual attached to the outdoor unit for the details of the “Cool/Heat selector”.



- Set a cool/heat selection eligibility as follows.

The icon “” (Changeover Under Control) will blink on all remote controllers when the power is turned on for the first time.

## Selection Settings

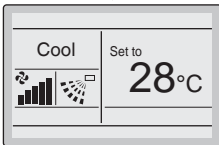
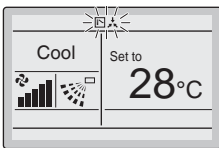
2



- Press Mode Selector button on the remote controller for which the selection eligibility to be set.  
Then the cool/heat selection eligibility will be set and the icon “” will disappear.  
The icon “” will appear on the other remote controllers.

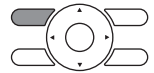

# 3

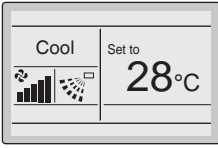

- Press Mode Selector button on the remote controller that has the cool/heat selection eligibility (the remote controller without the icon “”) several times until the desired mode is selected.  
The display will change to “Fan”, “Dry”, “Auto”, “Cool”, “Heat” each time the button is pressed.
- The display “Auto” will appear for the Heat Recovery system only.  
Simultaneously, the other remote controllers will follow suit and change the display automatically.

## Cool/Heat Selection Eligibility

- The “Cool”, “Heat”, “Auto” can be set by only the remote controller that has the cool/heat selection eligibility.  
(The display “Auto” will appear for the Heat Recovery System only.)

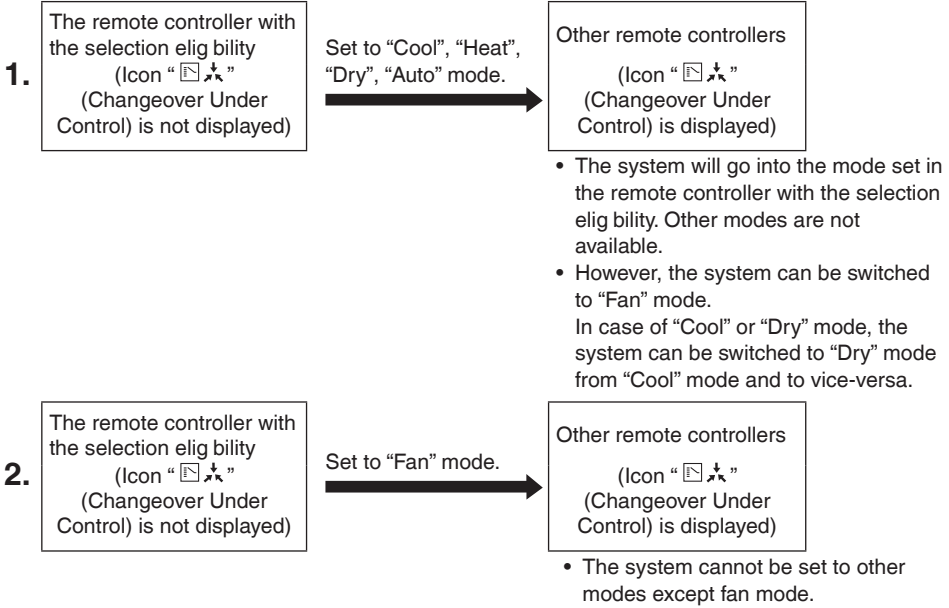

## Precautions for Setting Cool/Heat Selection Eligibility

- The cool/heat selection eligibility needs to be set for a single remote controller in the following case.

### (Heat Pump System)

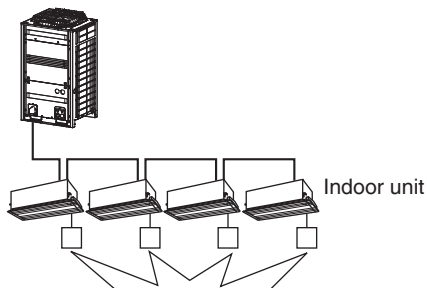

**A number of indoor units are connected to a single outdoor unit.**

Set the Cool/Heat/Fan mode selection eligibility in one of the remote controllers.

### (Heat Recovery System)

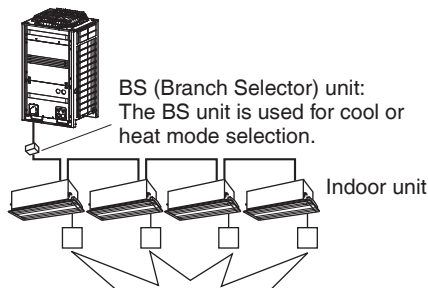

**A number of indoor units are connected to a single BS unit.**

Set the Cool/Heat/Auto/Fan mode selection eligibility in one of the remote controllers.

## Key Lock

**Operation** Make settings and cancel settings in the Basic screen.

1

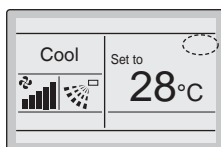



Basic screen

- Continue pressing Menu/Enter button for at least 4 seconds. (During backlight lit)

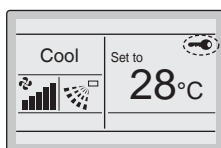

2



- "" will appear.
- All buttons are disabled when the keys are locked.
- To cancel the Key lock, continue pressing Menu/Enter button for at least 4 seconds. (During backlight lit)



# Quick Reference of Main Menu Items

## ■ Main Menu Items

Setting and display items		Description	Reference page
<b>Circulation Airflow</b> (Note 1, 4)		Control Airflow and Air Direction automatic, and send Airflow to the room generally. When release from the Circulation Airflow, you can set except the Airflow - Air Direction to be "Auto" or set the Circulation Airflow as <b>Enable</b> .	26
<b>Air Flow Direction</b> (only if the individual airflow function is installed)	<b>Individual setting</b>	Used to set an Airflow direction for maximum 4 flaps individually. <ul style="list-style-type: none"> <li>• In case of Sprit system, maximum 4 units (unit A, B, C, D)</li> <li>• In case of VRV, maximum 16 units (unit 0 to 15)</li> </ul>	27
	<b>Individual setting list</b>	Used to see the table for setting for maximum 4 flaps.	28
	<b>Reset All Indivi Setting</b>	Used to clear all of the individual settings.	29
	<b>Airflow direction range</b> (only available for floor standing type indoor unit (FVQ series))	Auto swing direction is selectable from 3 patterns to suit the layout of the room. <b>Standard, Right blow or Left blow</b>	29
<b>Quick Start</b> (SPLIT system only)		Used to set the room to a comfortable temperature quickly (unless the system is not in Dry or Fan operation). <ul style="list-style-type: none"> <li>• The maximum quick cooling/heating operation period is 30 minutes.</li> </ul>	30
<b>Ventilation</b> (Ventilation operation settings for Heat Reclaim Ventilator)	<b>Ventilation Rate</b>	Used to set to <b>Low</b> or <b>High</b> .	32
	<b>Ventilation Mode</b>	Used to set <b>Automatic, Energy Reclaim Ventilation, and Bypass</b> .	33
<b>Energy Saving Options</b>	<b>Energy Saving List</b>	<b>Enable</b> or <b>Disable</b> can be set up about the following menus.	34
	<b>Setpoint Range</b>	The set temperature range can be restricted. It is possible to restrict the temperature range based on a model and the mode of operation.	35
	<b>Setback Condition</b>	Determine the point when air conditioner is turned off again from the setback control. (recovery differential).	36
	<b>Sensing Sensor (Low)</b> (only if the sensing sensor is installed) (Note 2, 3)	When no people are detected during a continuously fixed time, the function will automatically change the air conditioning target temperature. If people are detected, it will return to the normal set temperature.	37
	<b>Sensing Sensor (Stop)</b> (only if the sensing sensor is installed) (Note 2, 3)	When no people are detected during a continuously fixed time, the function will automatically stop the air conditioner.	38

Setting and display items		Description	Reference page
<b>Energy Saving Options</b>	<b>Setpoint Auto Reset</b>	Even if the set temperature is changed, it returns to the preset temperature after progress of a defined period of time.	39
	<b>Off Timer</b>	After you turn on the air conditioner, it will automatically turn off in a defined period of time. <ul style="list-style-type: none"> <li>• Possible to set in 10 minutes increments from 30 to 180 minutes.</li> </ul>	40
	<b>Auto Display Off (All series correspond)</b>	While operation stopping, can turn off the LCD display. It will be displayed again if press any button. <p><b>Note:</b> Can be selected 10 minutes, 30 minutes, 60 minutes, and OFF, initial setting is 30 minutes.</p>	41
	<b>Energy consumption</b>	An energy consumption until now is displayed. This enables you to evaluate the trend of the energy consumption. <p><b>Note:</b> This function availability is depending on type of indoor unit.</p> <p><b>Note:</b> This function is not available in case more than 1 indoor unit are connected in group to the remote controller.</p> <p><b>Note:</b> Displayed energy consumption is not result of a kWh measurement, but results from a calculation with running data of the air conditioner. Some factors in this calculation are absolute values, but other factors merely result from interpolations with tolerance. This explains why the readout may deviate from the actual electricity consumption.</p>	42
<b>Schedule</b>	<b>Enable/Disable</b>	Enable or Disable of a schedule function can be changed.	48
	<b>Select Schedule</b>	The schedule number that must be active can be selected (schedule nr 1, 2 or 3).	44
	<b>Holidays</b>	Convenient holiday settings and temporary closure settings are possible.	45
	<b>Settings</b>	<ul style="list-style-type: none"> <li>• Set the startup time and operation stop time.</li> <li>• ON: Startup time, cooling and heating setting temperature can be configured.</li> <li>• OFF: Operation stop time, cooling and heating setback setting temperature can be configured. (---: Indicates that the setback function is disabled for this time period.)</li> <li>_: Indicates that the setting temperature and setback setting temperature for this time period is not specified. The last active setting temperature will be utilized.</li> <li>• Up to 5 actions can be set for each day.</li> </ul>	46
<b>Filter Auto Clean</b>		This function is available only on the model whose panel has filter auto clean function. For detailed operation refer to the operation manual of these models.	49

Setting and display items		Description	Reference page
<b>Maintenance Information</b>		<b>Used to display the service contact and model information.</b>	50
<b>Configuration</b>	<b>Quiet Operation Mode &lt;Outdoor unit&gt;</b> (sky air only)	<b>Setting period of time to operate priority on the quiet operation sound.</b> <ul style="list-style-type: none"> <li>• Period of start operate quiet operation sound ~ finish is able to set in unit of 30 minutes.</li> </ul>	51
	<b>Auto Airflow</b> (only model that have human detection sensor)	When set this function, at Air Direction Automatic setting, when detected human, it can change air direction to blow human or avoid from human.	54
	<b>Draft Prevention</b> (only model that have human detection sensor)	The draft prevention function can be enabled or disabled.	55
	<b>Display</b>	<b>Used to set to standard or detailed display mode.</b> <ul style="list-style-type: none"> <li>• Display Standard or detailed display</li> <li>• Detailed display settings Selectable from the display room temperature, outdoor air temperature, system or None.</li> </ul>	56
	<b>Contrast Adjustment</b>	<b>Used to make LCD contrast adjustment.</b>	58
<b>Current Settings</b>		<b>Used to display a list of current settings for available items.</b>	59
<b>Clock &amp; Calendar</b>	<b>Date &amp; Time</b>	<b>Used to configure date and time settings and corrections.</b> <ul style="list-style-type: none"> <li>• The default time display is 24H.</li> <li>• The clock will maintain accuracy to within <math>\pm 30</math> seconds per month.</li> <li>• If there is a power failure for a period not exceeding 48 hours, the clock will continue working with the built-in backup power supply.</li> </ul>	60
	<b>12H/24H Clock</b>	The time can be displayed in either a 12 hour or 24 hour time format.	62
	<b>Daylight Saving Time</b> (Note 5)	Used to set Daylight Saving Time to ON or OFF.	63
<b>Language</b>		The displayed language can be selected from the following language. (English/Deutsch/Français/Italiano/Español/Português/Nederlands)	64

Note: 1. Available setting items vary with the model connected.

Only the available setting items appear in the menu.

2. This function cannot be used at the time of group control.

3. In case of the simultaneous operation system, the system is controlled by the sensing sensor mounted in the master indoor unit.

4. Indoor unit inside group is all possible to set only in case of correspond to this function.

5. This function can be used only when Daylight Saving Time is enable.

## Menu Items of Sub Remote Controller

If 2 remote controllers are in control of a single indoor unit, the following menu items are not set in the sub remote controller. Set them in the main remote controller.

- Circulation Airflow
- Air Flow Direction
- Energy Saving Options
- Schedule
- Setback
- Filter Auto Clean
- Auto Airflow

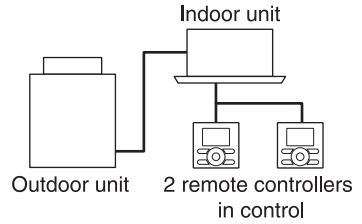

# Menu Manipulation

## Manipulating the Main Menu Screen

### ■ Display Method for Main Menu

#### Operation

1

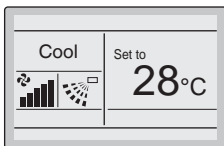

Basic screen

- Press Menu/Enter button.



2

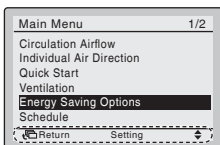

Main Menu screen

- The Main Menu screen will appear.

← Instructions for manipulating the buttons will appear.

3

- Select items from the Main Menu.
  1. Press “▼▲” buttons to select the desired item to be set.
  2. Press Menu/Enter button to display the selected settings screen.

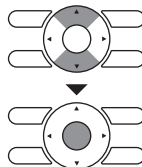

4

- To go back to the Basic screen from the Main Menu screen, press the Cancel button.



### Caution

- While setting items, if a button is not pressed for 5 minutes, the screen will automatically go back to the Basic screen.

# Circulation Airflow

## ■ Circulation Airflow Setting Method

In case of air direction individual setting is disable, Circulation Airflow cannot be used. Depends on model that does not have Circulation Airflow function and combination between option part, will not display the Circulation Airflow.

### Operation

1

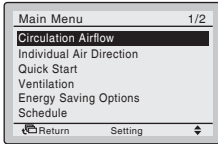

- Display the Main Menu screen (Refer to page 25).
- Press “▼▲” buttons to select **Circulation Airflow**. Press Menu/Enter button to display the Circulation Airflow screen.

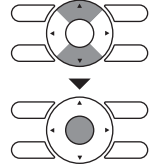

2

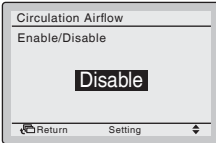

- Press “▼▲” buttons to change the setting to **Disable** or **Enable**. Press Menu/Enter button after selecting the item. The confirmation screen will appear.

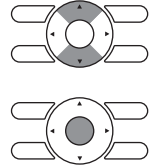

3

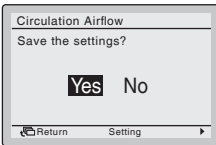

- Press “◀▶” buttons to select **Yes**. Press Menu/Enter button to confirm the settings and return to the Basic screen.

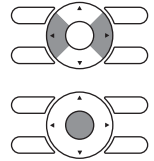

\* In case setting Circulation Airflow to be **Disable**, “Circulation” while operation of which Cooling · Heating · Auto will be displayed.

\* In case of group connection, it may take time until setting will be reflected.

\* In case of Circulation Airflow is setting as **Enable**, both Airflow · Air Direction when auto will be displayed as Auto.

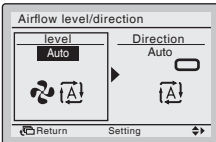

is icon shows Auto.

### Note:

- Circulation Airflow when operation start, will be repeated mutually horizontal blow and downward blowing (Heating), swing (Cool/Heat). Unit will judge automatically by temperature and time, and switch to normal the Airflow · Air Direction Auto operation. In this time, remote control screen will continue “Circulation”.
- In case would like to stop the Circulation Airflow operation while setting the Circulation Airflow disable, to press “Airflow/Air Direction” in the Basic screen, and change the Circulation Airflow again, to change both the Airflow · Air Direction from the Airflow/Air Direction setting screen to be **Auto**, or select **Disable** again from the Menu screen.

# Individual Air Direction

## ■ Individual Setting

### Operation

1

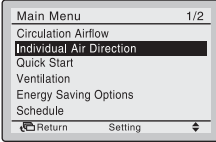

Main Menu screen

- Display the Main Menu screen (Refer to page 25).
- Select **Individual Air Direction** in the Main Menu.
- Press Menu/Enter button to display the Individual Air Direction settings screen.

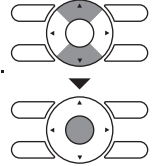

2

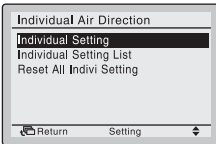

- Select **Individual setting**.
- Press Menu/Enter button.



3

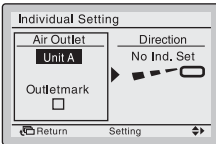

- Press “▼▲” buttons to select the unit and outlet mark.
- In case of four outlets, you can control each one of 4 flaps (ex. the following marks are beside each air outlet. □, □ □, □ □ □, □ □ □ □) individually.
- In case of SPLIT system, maximum 4 units (unit A, B, C, D) can be set.  
In case of VRV system, maximum 16 units for each group (unit 0 to 15) can be set.

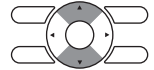

4

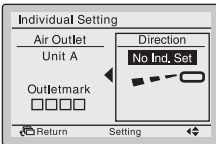

- Press “▶” button to select airflow direction setting.
- Press “▼▲” buttons to change the following settings: **No Ind. Set** **Position 0** **Position 1** **Position 2** **Position 3** **Position 4** **Swing**.  
**No Ind. Set**: No Individual Setting.
- Press Menu/Enter button to confirm the settings and return to the Basic screen.

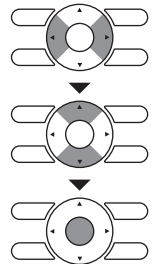

5

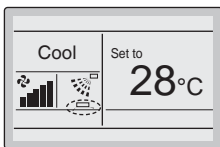

Basic screen

- If individual airflow direction is set, the Individual Airflow Direction icon “

## ■ Individual Setting List

### Operation

1

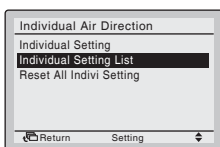

- Display the Individual Air Direction screen (Refer to page 27).
- Press “

2

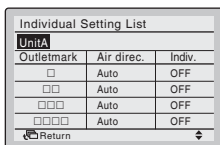

- A table shows the current settings. Press “



# Reset All Indivi Setting

## Operation

1

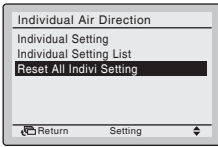

- Display the Individual Air Direction (Refer to page 27).
- Press “▼▲” buttons to select **Reset All Indivi Setting**.
- Press Menu/Enter button.

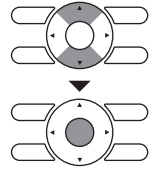

2

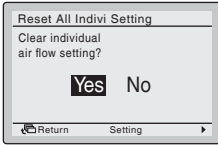

- Press “◀▶” buttons to select **Yes**.
- Press Menu/Enter button to confirm the reset and return to the Main Menu screen.

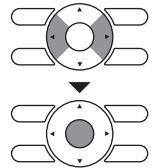

# Airflow Direction Range (Floor standing type indoor unit only)

- Air direction range can be selected by the remote controller depending on the installed location of the air conditioner.

Air direction range has the following 3 patterns.

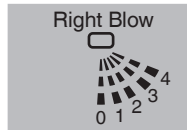
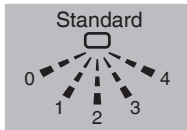
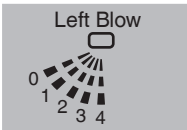

## Operation

1

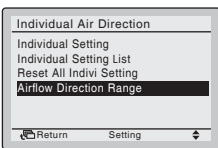

- Display the Individual Air Direction screen (Refer to page 27).
- Press “▼▲” buttons to select **Airflow Direction Range**.
- Press Menu/Enter button.

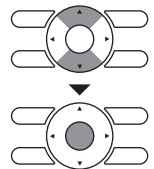

2

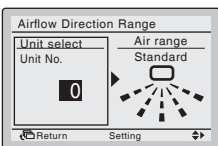

- Press “▼▲” buttons to select the unit No..
- \*For simultaneous operation system, individual setup for each indoor unit is possible by connecting the remote controller to each unit at the time of installation.
- For the remote controllers with grouping connection, maximum 16 units (0-15 as unit number) are configurable.

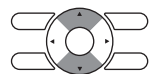

# 3

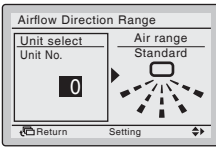

- Press “▶” button to select air range setting.

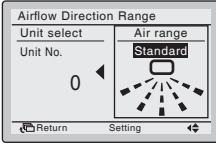

- Set the desired air range from **Standard**, **Right Blow** or **Left Blow** by using “▼▲” buttons.

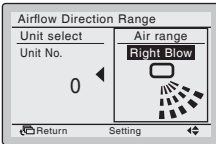
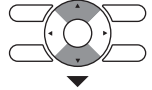

- Press Menu/Enter button to confirm the settings and return to the Basic screen.

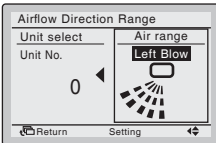

## Quick Start (SPLIT system only)

### ■ Quick Start On

#### Operation

# 1

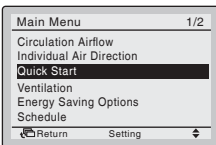

- While operating in Cooling, Heating, or Auto mode, display the Main Menu screen (Refer to page 25).
- Press “▼▲” buttons to select **Quick Start** on the Main Menu screen.

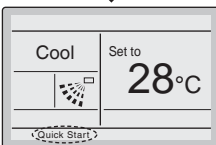
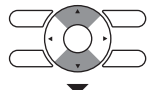

- Press Menu/Enter button to return to the Basic screen.
- “Quick Start” will appear on the Basic screen.
- Quick Start is now on.



# ■ Quick Start Off

## Operation

2

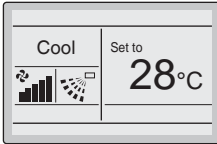
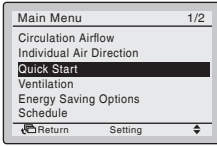

- While Quick Start is displayed on the Basic screen, display the Main Menu screen (Refer to page 25).
- Press “▼▲” buttons to select **Quick Start**. Press Menu/Enter button to return to the Basic screen.
- “Quick Start” will no longer appear on the Basic screen.
- Quick Start is now off.

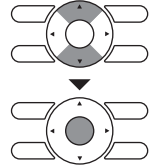

## Quick Start

### Quick Start

The airflow rate of indoor unit is automatically controlled, increasing the capacity of the outdoor unit and quickly bringing the room to a comfortable temperature.

- Airflow rate display disappear and airflow rate can no longer be switched.
- Cannot be set when in fan and dry modes.
- Quick Start will operate for a maximum of 30 minutes before the air conditioner automatically returns to normal operation.
- Activating mode selector will return the air conditioner to normal operation.
- In heating mode, airflow rate will increase and the air outlet temperature may decrease. Adjust the operation as desired.

# Ventilation

## ■ Display Method for Ventilation Screen

### Operation

1

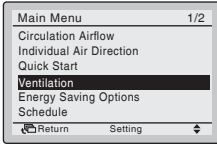

- Display the Main Menu screen. (Refer to page 25.)
- Press “▼▲” buttons to select **Ventilation**. (For models with no ventilation function, **Ventilation** will not be displayed.) Press Menu/Enter button to display the Ventilation screen.

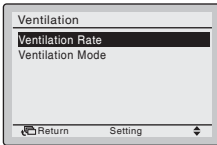
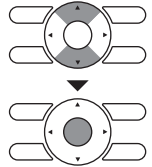

## ■ Changing the Ventilation Rate

### Operation

1

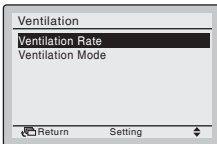

- Display the Ventilation settings screen (Refer to above).
- Press “▼▲” buttons to select **Ventilation Rate**. Press Menu/Enter button to display the Ventilation rate screen.

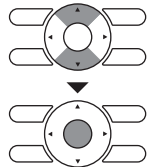

2

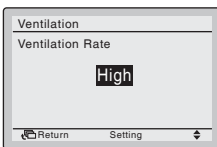

- Press “▼▲” buttons to change the setting to **Low** or **High**.

\* Only modes that can be set are displayed.



Low ↔ High

3

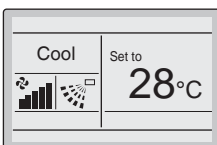

- Select the desired ventilation rate. Press Menu/Enter button to confirm the settings and return to the Basic screen. (Press Cancel button to return to the previous screen without changing the ventilation rate.)



# ■ Changing the Ventilation Mode

## Operation

1

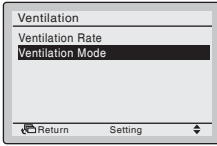

- Display the ventilation screen. (Refer to page 32.)
- Press “▼▲” buttons to select **Ventilation Mode**. Press Menu/Enter button to display the Ventilation mode screen.

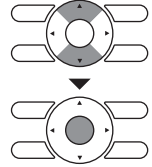

2

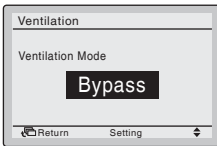

- Press “▼▲” buttons to change the settings in order as shown below.



\* Only modes that can be set are displayed.

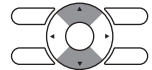

3

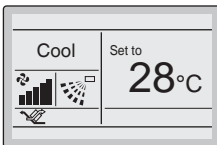

- Select the desired ventilation mode. Press Menu/Enter button to confirm the settings and return to the Basic screen. (Press the Cancel button to return to the previous screen without changing the ventilation mode.)



## Ventilation Mode

### Automatic mode

Using information from the air conditioner (cooling, heating, fan and set temperature) and the Heat Reclaim Ventilator unit (indoor and outdoor air temperatures), mode is automatically changed between Energy reclaim ventilation and Bypass.

### Energy reclaim ventilation mode

Outdoor air is supplied to the room with undergoing heat exchange.

### Bypass mode

Outdoor air is supplied to the room without undergoing heat exchange.

# Energy Saving Options

## ■ Display Method for Energy Saving Options Screen

### Operation

1

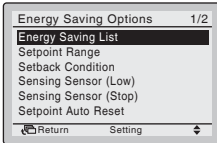
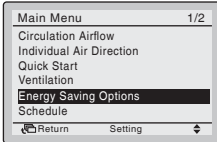

- Display the Main Menu screen. (Refer to page 25.)
- Press “▼▲” buttons to select **Energy Saving Options**. Press Menu/Enter button to display the Energy Saving Options screen.

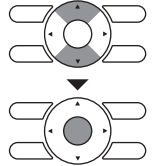

## ■ Energy Saving List

### Operation

1

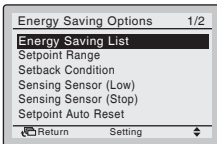

- Display the Energy Saving Options screen (Refer to above).
- Press “▼▲” buttons to select **Energy Saving List**. Press Menu/Enter button to display the Energy Saving List screen.

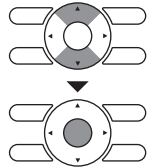

2

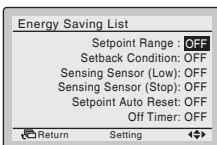

- Press “▼▲” buttons to change the setting to **ON** or **OFF**. (**ON** : Enable, **OFF** : Disable)
- Press “◀▶” buttons to move the cursor. Press Menu/Enter button after selecting the item. The confirmation screen will appear.

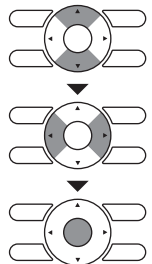

3

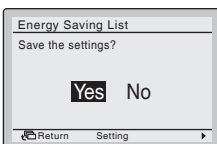

- Press “◀▶” buttons to select **Yes** on the confirmation screen. Press Menu/Enter button to confirm the settings and return to the Basic screen.

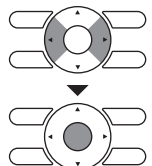

# ■ Setpoint Range

## Operation

1

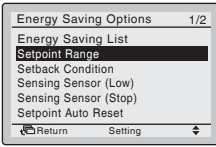

- Display the Energy Saving Options screen (Refer to page 34).
- Press “▼▲” buttons to select **Setpoint Range**. Press Menu/Enter button to display the Setpoint Range screen.

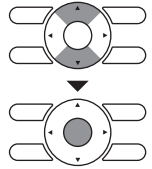

2

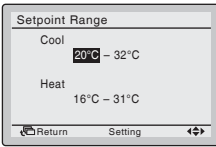

- Press “▼▲” buttons to change the temperature setting range of cooling and heating.
- Press “◀▶” buttons to move the cursor. Press Menu/Enter button after selecting the item. The confirmation screen will appear.

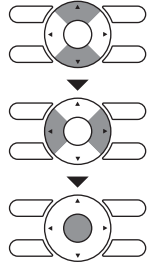

3

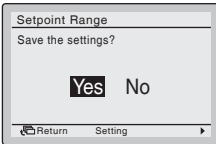

- Press “◀▶” buttons to select **Yes**. Press Menu/Enter button to confirm the settings and return to the Basic screen.

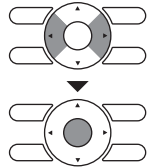

# ■ Setback Condition

## Operation

1

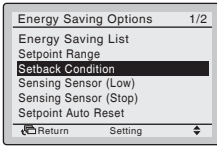

- Display the Energy Saving Options screen (Refer to page 34).
- Press “▼▲” buttons to select **Setback Condition**. Press Menu/Enter button to display the Setback Condition screen.

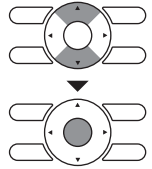

2

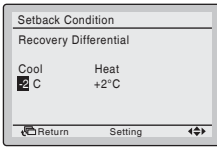

- Press “▼▲” buttons to change the temperature differential of the Setback.
- Press “◀▶” buttons to move the cursor. Press Menu/Enter button after selecting the item. The confirmation screen will appear.

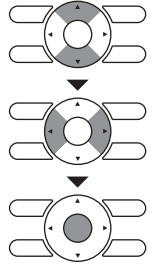

3

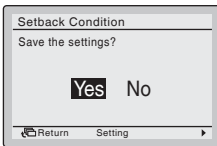

- Press “◀▶” buttons to select **Yes**. Press Menu/Enter button to confirm the settings and return to the Basic screen.

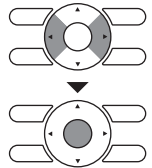



## ■ Sensing Sensor (Low)

This function cannot be used at the time of group control.

In case of the simultaneous operation system, the system is controlled by the sensing sensor mounted in the master indoor unit.

### Operation

# 1

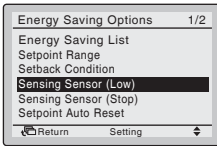

- Display the Energy Saving Options screen (Refer to page 34).
- Press “▼▲” buttons to select **Sensing Sensor (Low)**. Press Menu/Enter button to display the Sensing Sensor (Low) screen.

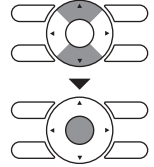

# 2

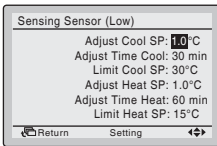

- Press “▼▲” buttons to change the setting value of saving energy operation when the sensor detects the absence.
- Press “◀▶” buttons to move the cursor. Press Menu/Enter button after selecting the item. The confirmation screen will appear.

(Example)

Adjust Cool SP	: 1.0°C
Adjust Time Cool	: 30 min
Limit Cool SP	: 30°C

- If it is determined that there is no person in the room by sensor during Cooling Operation, the set temperature will automatically shift by 1°C every 30 minutes until the set temperature is 30°C. (On Basic screen, set temperature does not change.)

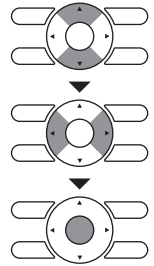

# 3

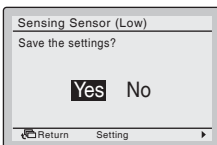

- Press “◀▶” buttons to select **Yes**. Press Menu/Enter button to confirm the settings and return to the Basic screen.

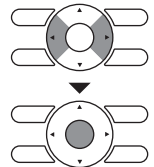

# ■ Sensing Sensor (Stop)

This function cannot be used at the time of group control.

In case of the simultaneous operation system, the system is controlled by the sensing sensor mounted in the master indoor unit.

## Operation

1

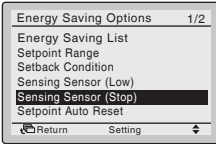

- Display the Energy Saving Options screen (Refer to page 34).
- Press “▼▲” buttons to select **Sensing Sensor (Stop)**. Press Menu/Enter button to display the Sensing Sensor (Stop) screen.

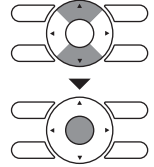

2

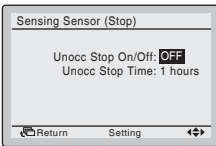

- Press “▼▲” buttons to set the saving energy operation when the sensor detects the absence.
- Press “◀▶” buttons to move the cursor. Press Menu/Enter button after selecting the item. The confirmation screen will appear.

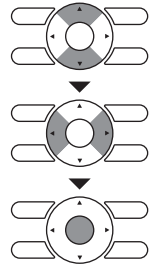

3

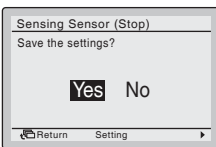

- Press “◀▶” buttons to select **Yes**. Press Menu/Enter button to confirm the settings and return to the Basic screen.

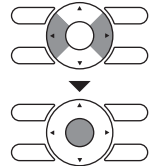

# ■ Setpoint Auto Reset

## Operation

1

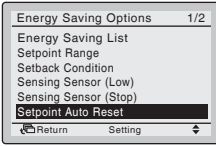

- Display the Energy Saving Options screen (Refer to page 34).
- Press “▼▲” buttons to select **Setpoint Auto Reset**. Press Menu/Enter button to display the Setpoint Auto Reset screen.

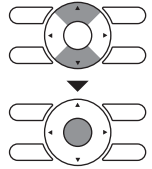

2

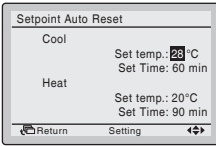

- Press “▼▲” buttons to set preset temperature and timing for the auto reset of the setpoint.
- Press “◀▶” buttons to move the cursor. Press Menu/Enter button after selecting the item. The confirmation screen will appear.

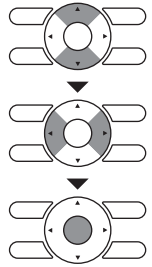

3

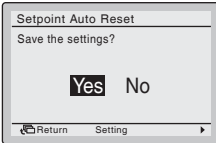

- Press “◀▶” buttons to select **Yes**. Press Menu/Enter button to confirm the settings and return to the Basic screen.

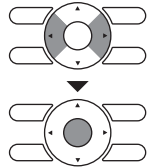

# ■ Off Timer

## Operation

1

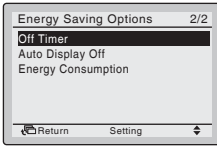

- Display the Energy Saving Options screen. (Refer to page 34.)
- Press “▼▲” buttons to select the **Off Timer**. Press Menu/Enter button to display the Off Timer screen.

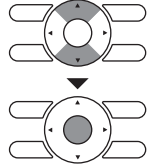

2

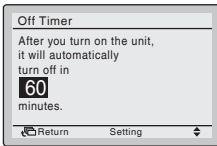

- Press “▼▲” buttons to set the time from operation start until the unit automatically stops. Selections can be made in increments of 10 minutes from 30 to 180 minutes. Holding down the button causes the number to change continuously.
- Select the desired time and press Menu/Enter button. The confirmation screen will appear.

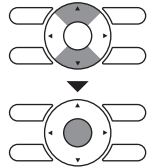

3

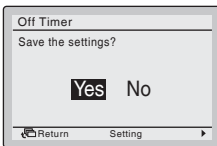

- Press “◀▶” button to select **Yes**. Press Menu/Enter button to confirm the Off Timer settings and return to the Basic screen.

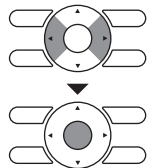

# ■ Auto Display Off

## Operation

1

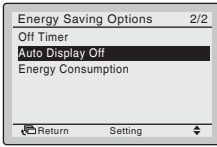

- Display the Energy Saving Options screen. (Refer to page 34.)
- Press “▼▲” buttons to select **Auto Display Off**. Press Menu/Enter button to display the Auto Display Off screen.

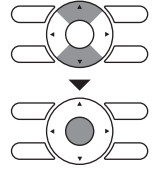

2

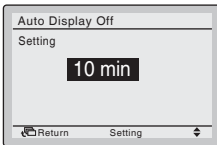

- Press “▼▲” buttons to set the Auto Display Off from **10 min**, **30 min**, **60 min** or **OFF**. Press Menu/Enter button after selecting the item. The confirmation screen will appear.

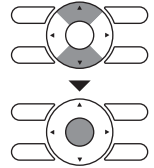

3

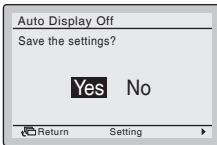

- Press “◀▶” button to select **Yes**. Press Menu/Enter button to confirm the settings and return to the Basic screen.

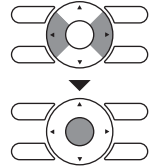

# Energy Consumption

**Operation** This item may not be available depend on the connecting model.

1

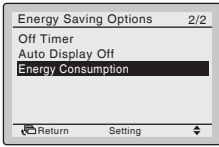

- Display the Energy Saving Options screen (Refer to page 34).
- Press “▼▲” buttons to select **Energy Consumption**. Press Menu/Enter button to display the Energy Consumption screen.

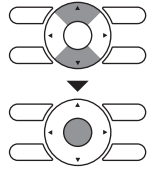

2

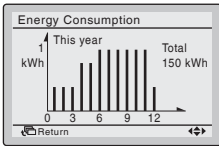
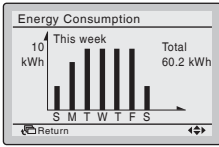
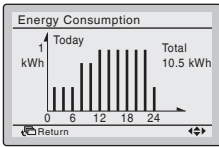

- Press “◀▶” buttons to move the indicating screen. Today > Yesterday > This week (1 week) > Last week (1 week) > This year (1 year) > Last year. Change the items and values located in the upper right of the indication area using “▼▲” buttons.

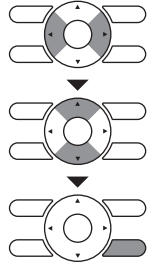

Press Cancel button to return to the previous screen.

# Schedule

## ■ Display Method for Schedule Screen

**Operation** The Schedule cannot be enabled when a centralized control equipment is connected.

1

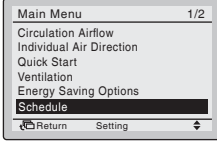

- Display the Main Menu screen. (Refer to page 25.)
- Press “▼▲” buttons to select **Schedule**. Press Menu/Enter button to display the Schedule screen.

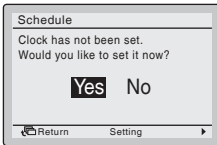
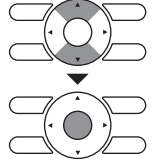

- Before setting the schedule, the clock must be set.
- If the clock has not been set, a screen like the one on the left will appear. Press “◀▶” buttons to select **Yes** and press Menu/Enter button.

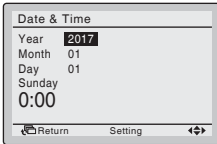

- The Date & Time screen will appear.
- Set the current Year, Month, Day, and Time. (Refer to “Clock & Calendar” on page 60.)

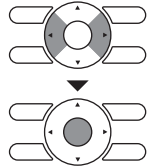

2

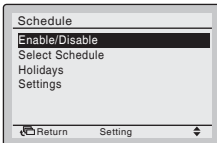

- Press “▼▲” buttons to select the desired item on the Schedule screen and press Menu/Enter button.

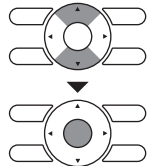

# ■ Select Schedule

**Operation** This function can be stored in the schedule of 3 patterns.

1

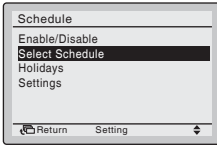

- Display the Schedule screen. (Refer to page 43.)
- Press "▼▲" buttons to select **Schedule nr set**. Press Menu/Enter button to display the Schedule nr set screen.

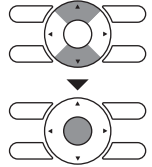

2

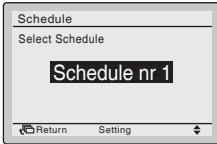

- Press "▼▲" buttons to select **Schedule nr 1**, **Schedule nr 2**, or **Schedule nr 3**. Press Menu/Enter button after selecting the item. The confirmation screen will appear.

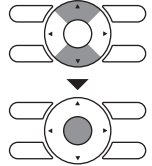

3

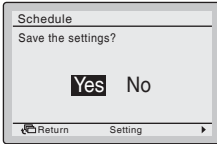

- Press "◀▶" buttons to select **Yes**. Press the Menu/Enter button to confirm the daily patterns in the schedule and return to the Basic screen.

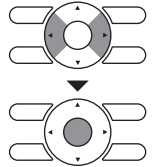



# ■Holidays

(The schedule timer will be disabled for days that have been set as holiday.)

## Operation

1

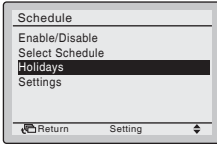

- Display the Schedule screen. (Refer to page 43.)
- Press “▼▲” buttons to select **Holidays**. Press Menu/Enter button to display the Holiday setting screen.

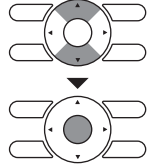

2

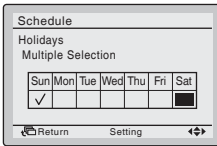

- Press “◀▶” buttons to select the desired day. Press “▼▲” buttons to display “✓” to make the holiday settings. Press “▼▲” buttons to switch the setting between set and release.

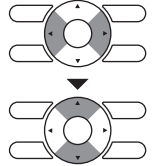

Multiple days can be selected as holidays.

Note: To enable the schedule timer for the day selected as a holiday, the holiday setting must be released.

3

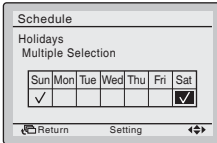

- To complete the holiday settings, press Menu/Enter button. The confirmation screen will appear.

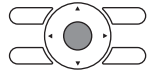

4

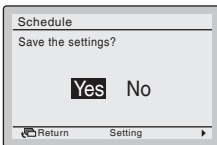

- Press “◀▶” button to select **Yes**. Press Menu/Enter button to confirm the holiday settings and return to the Basic screen.

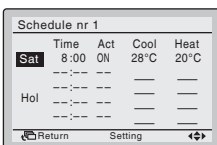
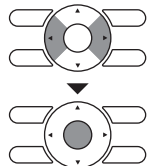

### Note:

- Holidays that are set will be displayed on the Schedule screen.

# ■ Schedule Settings

## Operation

1

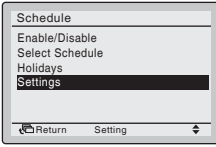

- Display the Schedule screen. (Refer to page 43.)
- Press “▼▲” buttons to select **Settings**. Press Menu/Enter button to display the Schedule screen.

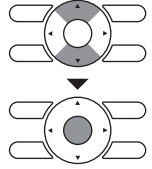

NOTE: The Schedule Settings of the selected schedule number can be changed. To change the schedule number refer to “Schedule Nr Set” on page 44.

2

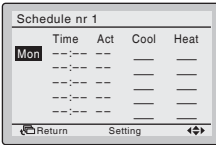

- Press “▼▲” buttons to select the day of the week to be set.

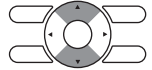

3

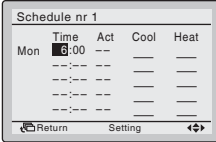

- Set the time for the selected day.
- Press “◀▶” buttons to move the highlighted item and press “▼▲” buttons to set the desired time. Each press of “▼▲” buttons moves the numbers by 1 hour or 1 minute.

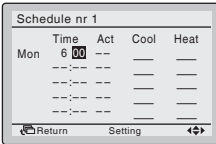
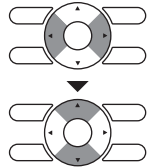

4

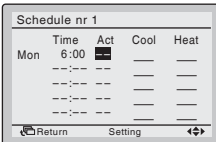

- Press the “◀▶” buttons to move the highlighted item and press “▼▲” buttons to configure ON/OFF/-- settings. --, ON, or OFF changes in sequence when “▼▲” buttons are pressed.

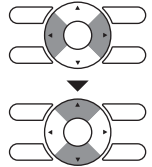

### “Act” column:

- ON : The set temperature can be configured.
- OFF: The setback temperature can be configured.
- : The set temperature and setback temperature become disabled.

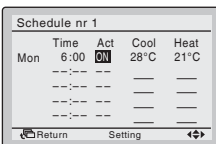

Schedule nr 1				
	Time	Act	Cool	Heat
Mon	6:00	ON	28°C	21°C
	8:00	OFF	35°C	10°C
	---	---	---	---
	---	---	---	---
	---	---	---	---
	---	---	---	---
		Return	Setting	↔

- The cooling and heating set temperature for both ON and OFF (Setback) are configured.

**“Cool” and “Heat” column:**

“\_” : Indicates that the set temperature and setback temperature for this time period is not specified. The last active set temperature will be utilized.

“--” : Indicates that the setback function is disabled for this time period.

5

Schedule nr 1				
	Time	Act	Cool	Heat
Mon	6:00	ON	28°C	21°C
	8:00	OFF	35°C	10°C
	17:30	ON	28°C	21°C
	22:00	---	---	---
	---	---	---	---
	---	---	---	---
		Return	Setting	↔

A maximum of 5 actions per day can be set.

- Press the Menu/Enter button when settings for each day are completed. The confirmation screen will appear.

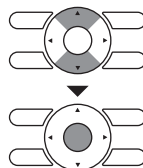

Schedule nr 1				
	Time	Act	Cool	Heat
Mon	6:00	ON	28°C	21°C
	8:00	OFF	35°C	10°C
	17:30	ON	28°C	21°C
	22:00	OFF	35°C	10°C
	---	---	---	---
	---	---	---	---
		Return	Setting	↔



Schedule nr 1				
	Time	Act	Cool	Heat
Tue	---	---	---	---
	---	---	---	---
	---	---	---	---
	---	---	---	---
	---	---	---	---
	---	---	---	---
		Return	Setting	↔

**Note:**

- To copy the settings for the previous day, press the Mode Selector button so that the existing settings will be copied.

Example: The contents for Monday are copied by pressing the Mode Selector button after selecting Tuesday.



Schedule nr 1				
	Time	Act	Cool	Heat
Tue	6:00	ON	28°C	21°C
	8:00	OFF	35°C	10°C
	17:30	ON	28°C	21°C
	22:00	OFF	35°C	10°C
	---	---	---	---
	---	---	---	---
		Return	Setting	↔

6

Schedule	
Save the settings?	
Yes	No
Return Setting	

- Press “◀▶” buttons to select **Yes**. Press the Menu/Enter button to confirm the settings for each day and return to the Basic screen.

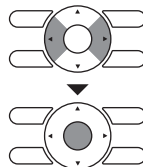



## Enabling or disabling the schedule

### Operation

1

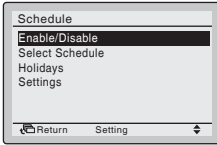

- Display the Schedule screen. (Refer to page 43.)
- Press “▼▲” buttons to select **Enable/Disable**. Press Menu/Enter button to display the Enable/Disable screen.

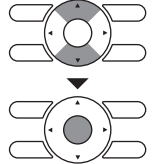

2

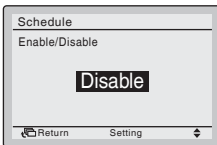

- Press “▼▲” buttons to select **Enable** or **Disable** on the Enable/Disable screen. Press Menu/Enter button after selecting the item. The confirmation screen will appear.

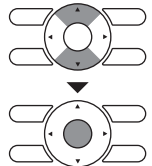

NOTE: The Schedule number selected is Enabled. To change the Schedule number see “Schedule Nr Set” on page 44.

3

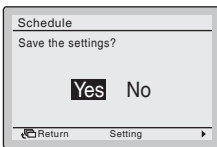

- Press “◀▶” buttons to select **Yes**. Press Menu/Enter button to confirm the Enable/Disable setting for the schedule and return to the Basic screen.

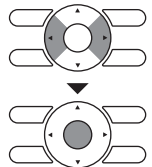

# Filter Auto Clean

## Operation

1

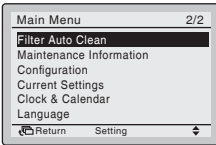

- Display the Main Menu screen. (Refer to page 25.)
- Press “▼▲” buttons to select **Filter Auto Clean** and press Menu/Enter button.

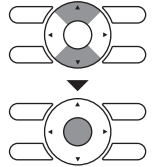

2

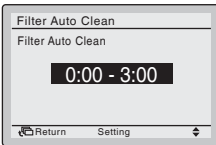

- Filter Auto Clean time zone setting can be set.
- This function is available only on the model whose panel has Filter Auto Clean function.
- For detailed operation, refer to the operation manual of these models.

# Maintenance Information

## ■ Display Method for Maintenance Information

### Operation

1

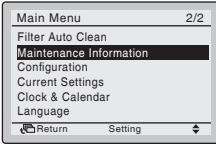

- Display the Main Menu screen. (Refer to page 25.)
- Press “▼▲” buttons to select **Maintenance Information** and press Menu/Enter button.

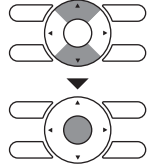

2

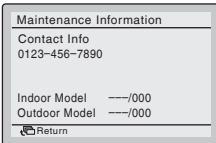

- The phone number for the contact is displayed at the top of the screen. (If it has not yet registered by installer, it will not displayed.)
  - The model name of the indoor and outdoor units of your product will be displayed on the bottom of the screen. (For some models the product code may be displayed instead of model name.)
- \* The model name will not displayed if the Printed Circuit Board of the air conditioner has been replaced.

- \* The Malfunction (Error) code history may also be displayed. If it is not blinking, the unit is working properly. The Malfunction (Error) code history is no longer displayed if you press ON/OFF button for more than 4 seconds.



# Configuration

## ■ Display Method for Configuration Screen

### Operation

1

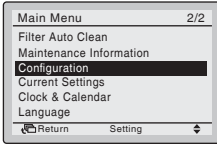

- Display the Main Menu screen. (Refer to page 25.)
- Press “▼▲” buttons to select **Configuration**. Press Menu/Enter button to display the Configuration screen.

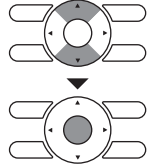

## ■ Quiet Operation Mode <Outdoor unit> (SkyAir only)

### Operation

1

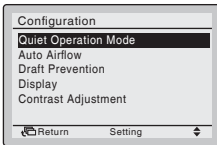

- Display the Configuration screen. (Refer to above.)
- Press “▼▲” buttons to select **Quiet Operation Mode**. Press Menu/Enter button to display the Quiet Operation Mode screen.

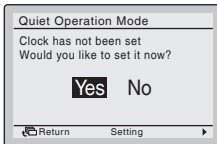
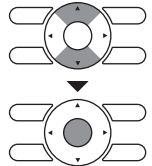

- Before setting the Quiet Operation Mode, the clock must be set.
- If the clock has not been set, a screen like the one on the left will appear. Press “◀▶” buttons to select **Yes** and press Menu/Enter button
- The Date & Time screen will appear.
- Set the current Year, Month, Day and Time. (Refer to “Clock & Calendar” on page 60.)

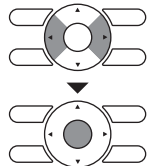
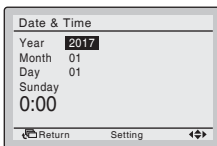

2

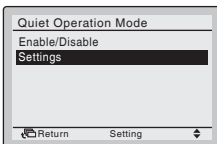

- Press “▼▲” buttons to select **Settings**. Press Menu/Enter button to display the Quiet Operation Mode screen.

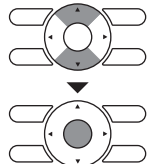

3

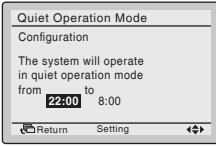

- Press “◀▶” buttons to select the Start time or Finish time.  
Press “▼▲” buttons to set the Start time, can set by unit of 30 minutes.  
If continue pressing, it will change continuously.

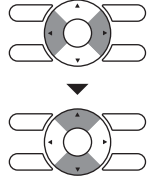

4

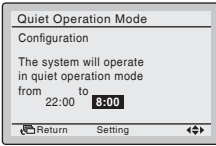

- Press “◀▶” buttons to select the Finish time.  
Press “▼▲” buttons to set the Finish time, can set by unit of 30 minutes.  
If continue pressing, it will change continuously.
- Press Menu/Enter button after selecting the item.  
The confirmation screen will appear.

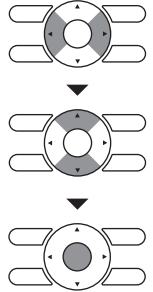

5

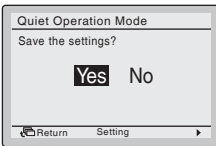

- Press “◀▶” buttons to select **Yes**.  
Press the Menu/Enter button to confirm the Quiet Operation Mode settings and return to the Basic screen.

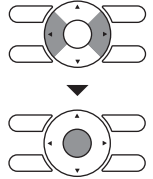





## Enabling or disabling the Quiet Operation Mode

### Operation

1

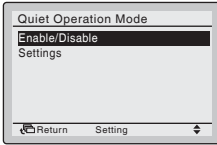

- Display the Quiet Operation Mode screen. (Refer to page 51.)
- Press “▼▲” buttons to select **Enable/Disable**. Press Menu/Enter button to display the Enable/Disable screen.

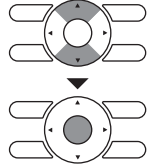

2

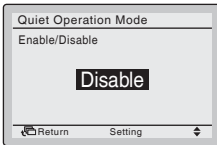

- Press “▼▲” buttons to select **Enable** or **Disable** on the Enable/Disable screen. Press Menu/Enter button after selecting the item. The confirmation screen will appear.
- Press “◀▶” buttons to select **Yes**. Press Menu/Enter button to confirm the Enable/Disable setting for the Quiet Operation Mode and return to the Basic screen.

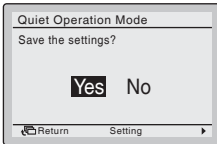
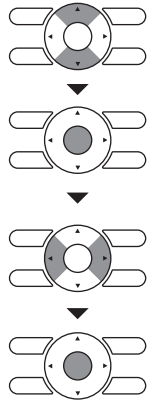

# ■ Auto Airflow

## Cool and Heat Condition setting method

**Operation** Menu will be displayed only corresponded model.

1

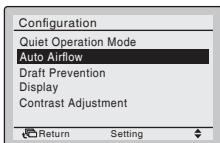

- Display the Configuration screen. (Refer to page 51.)
- Press “▼▲” buttons to select **Auto Airflow**. Press Menu/Enter button to display the Active Draft screen.

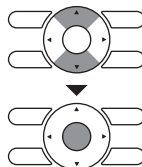

2

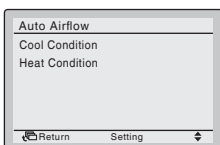

- Press “▼▲” buttons to select **Cool Condition**. Press Menu/Enter button to display the Condition Setting screen.

\* In case of heating, select the Heat Condition

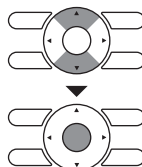

3

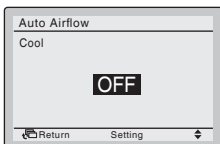

- Press “▼▲” buttons to select **OFF**, **Draft Prevention** or **Direct Air**. Press Menu/Enter button after selecting the item. The confirmation screen will appear.

- Press “◀▶” buttons to select **Yes**. Press Menu/Enter button to confirm the enable/disable setting for the Auto Airflow and return to the Basic screen.

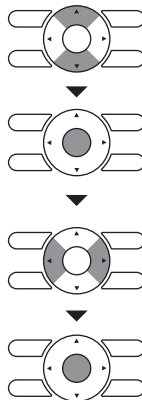
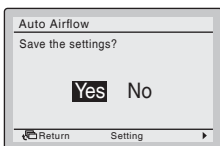

# ■ Draft Prevention

## Operation

1

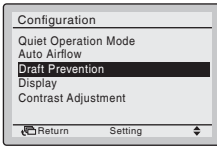

- Display the Configuration screen. (Refer to page 51.)
- Press “▼▲” buttons to select **Draft Prevention**. Press Menu/Enter button to display the Draft Prevention screen.

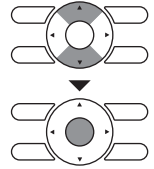

2

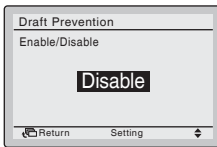

- Press “▼▲” buttons to select **Enable** or **Disable**. Press Menu/Enter button after selecting the item. The confirmation screen will appear.

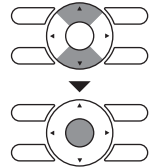

3

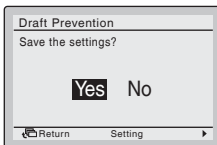

- Press “◀▶” buttons to select **Yes**. Press Menu/Enter button to confirm the Enable/Disable setting for the Draft Prevention and return to the Basic screen.

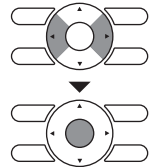

# ■ Display

## Display Mode

### Operation

1

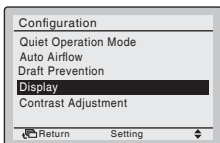

- Display the Configuration screen. (Refer to page 51.)
- Press “▼▲” buttons to select **Display**. Press Menu/Enter button to display the Display screen.

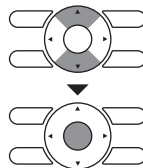

2

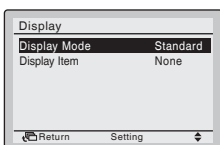

- Press “▼▲” buttons to select **Display Mode**. Press Menu/Enter button to display the Display Mode screen.

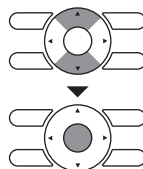

3

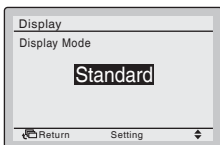

- Press “▼▲” buttons to select **Standard** or **Detailed**.
- Then, press Menu/Enter button to confirm settings and return to the Basic screen.

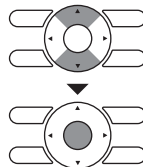

# Setting the detailed display item selection

## Operation

1

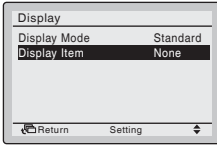

- Display the Display screen. (Refer to page 56.)
- Press “▼▲” buttons to select **Display Item**. Press Menu/Enter button to display the Display Item screen.

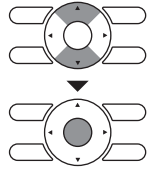

2

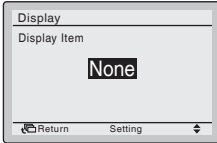

- Press “▼▲” buttons to display the following.

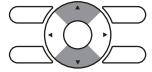

\* Some models may not display these items even if they are selected.

- Be sure to read the following notes regarding display of room temperature and outdoor air temperature.

### Room Temp

..... The temperature detected near the remote controller.  
 The temperature may be affected by the location of the remote controller.

### Outside Air Temp

..... The temperature detected near the outdoor unit.  
 The temperature may be affected by factors such as the location of the outdoor unit (in direct sunlight, e.g.) and unit operation during defrosting.

- After setting, press Menu/Enter button to confirm settings and return to the Basic screen.



# ■ Contrast Adjustment

## Operation

1

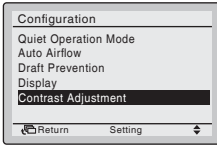

- Display the Configuration screen. (Refer to page 51.)

- Press “▼▲” buttons to select

### **Contrast Adjustment.**

Press Menu/Enter button to display the Contrast Adjustment screen.

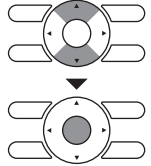

2

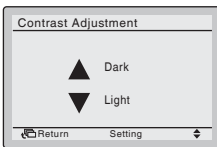

- On the Contrast Adjustment screen, press “▼▲” buttons until you reach the desired contrast.

After setting, press Menu/Enter button and return to the Basic screen.

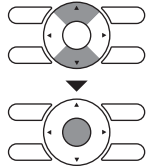

# Current Settings

## ■ Manipulating the Current Settings

### Operation

1

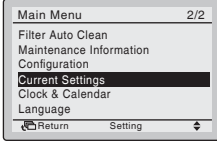

- Display the Main Menu screen. (See page 25.)
- Press “▼▲” buttons to select **Current Settings** and press Menu/Enter button.

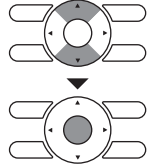

2

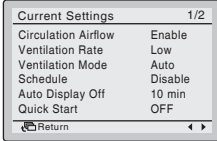

- A list of the current setting status will appear. Press “◀▶” buttons to go to the next item.
- Press Cancel button to return to the Main Menu screen.

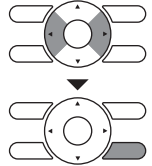

#### Display items

Circulation Airflow	Quick Start
Ventilation Rate	Quiet Operation Mode
Ventilation Mode	Display Mode
Schedule	Display Item
Auto Display Off	Filter Auto Clean

\* Display items may differ depending on the model.  
Only the items that can be set are displayed.

# Clock & Calendar

## ■ Display Method for Clock & Calendar Screen

### Operation

1

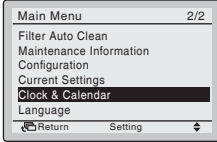

- Display the Main Menu screen. (Refer to page 25.)
- Press “▼▲” buttons to select **Clock & Calendar**. Press Menu/Enter button to display the Clock & Calendar screen.

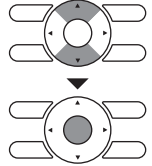

## ■ Date & time

### Operation

1

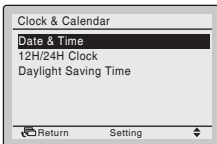

- Display the Clock & Calendar screen. (Refer to above.)
- Press “▼▲” buttons to select **Date & Time**. Press Menu/Enter button to display the Date & Time screen.

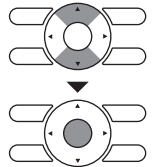

2

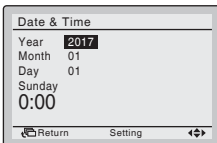

- Select “Year” with “◀▶” buttons. Change the year with “▼▲” buttons. Holding down the button causes the number to change continuously.

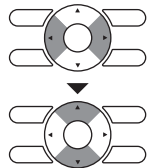

3

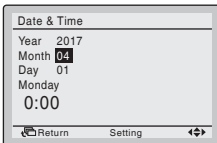

- Select “Month” with “◀▶” buttons. Change the month with “▼▲” buttons. Holding down the button causes the number to change continuously.

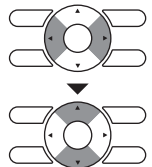



---

# 4

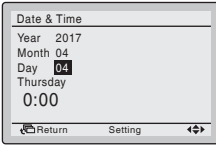

- Select “Day” with “◀▶” buttons.  
Change the day with “▼▲” buttons.  
Holding down the button causes the number to change continuously.  
Days of the week change automatically.

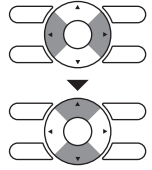

---

# 5

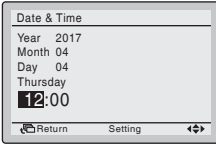

- Select “Hour” with “◀▶” buttons.  
Change the hour with “▼▲” buttons.  
Holding down the button causes the number to change continuously.

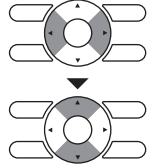

---

# 6

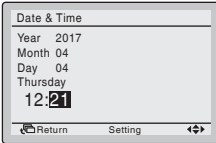

- Select “Minute” with “◀▶” buttons.  
Change the minute with “▼▲” buttons.  
Holding down the button causes the number to change continuously.
- Press Menu/Enter button.  
The confirmation screen will appear.

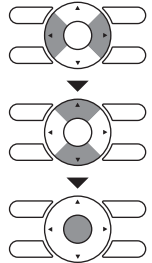

---

# 7

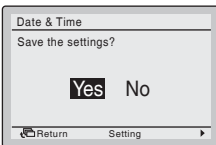

- Press “◀▶” button to select **Yes**.  
Press Menu/Enter button to confirm the clock and return to the Basic screen.

\* When setting the schedule, the display returns to the Schedule screen.

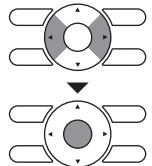

# ■ 12H/24H Clock

## Operation

1

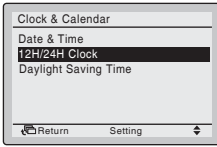

- Display the Clock & Calendar screen. (Refer to page 60)
- Press “▼▲” buttons to select **12H/24H Clock**. Press Menu/Enter button to display the 12H/24H Clock screen.

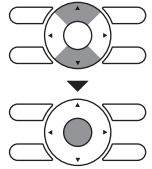

2

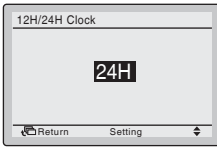

- By default, the time display is set to the 24H format.
- Press “▼▲” buttons to select **12H** or **24H**.
  - Press Menu/Enter button after selecting the item. The confirmation screen will appear.

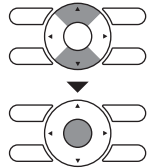

3

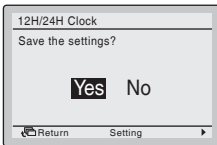

- Press “◀▶” buttons to select **Yes**. Press the Menu/Enter button to confirm the 12H or 24H and return to the Basic screen.

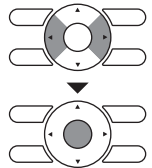

# ■ Daylight Saving Time

## Operation

1

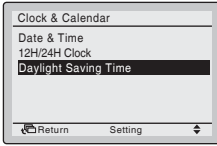

- Display the Clock & Calendar screen. (Refer to page 60.)
- Press “▼▲” buttons to select **Daylight Saving Time**.

Press Menu/Enter button to display the Daylight Saving Time screen.

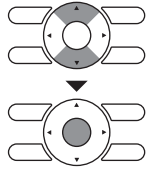

2



- Press “▼▲” buttons to select **ON** or **OFF**.
- Press Menu/Enter button after selecting the item. The confirmation screen will appear.

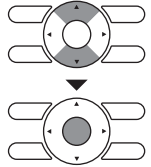

3

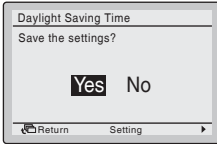

- Press “◀▶” buttons to select **Yes**. Press the Menu/Enter button to confirm the Daylight Saving Time and return to the Basic screen.

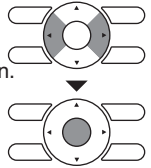

# Language

## ■ Selectable Languages

### Operation

1

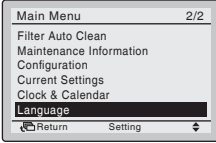

- Display the Main Menu screen. (Refer to page 25.)
- Press “▼▲” buttons to select **Language** and press the Menu/Enter button.

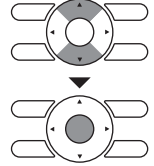

2

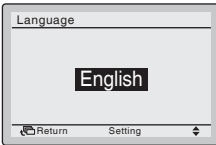

- Press “▼▲” buttons to select the preferred language from following.  
English/Deutsch/Français/Italiano/Español/  
Português/Nederlands
- Press Menu/Enter button to confirm settings and return to the Basic screen.

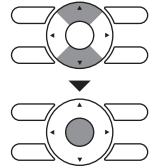

# Maintenance

## Reset Filter Indicator

### Operation

1

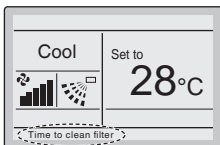

- When the time to clean the filter or element has come, one of the following messages will appear on the bottom of the Basic screen.
  - “Time to clean filter”
  - “Time to clean filter & element”
  - “Time to clean element”

- Wash, clean, or replace the filter or element.  
For details, refer to the operation manual attached to the indoor unit.

2

- Reset the filter indicator when the filter or element is washed, cleaned, or replaced.
- Press Menu/Enter button.  
The Main Menu screen will appear.



3

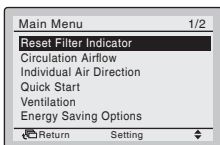

- Press “▼▲” buttons to select **Reset Filter Indicator** and press Menu/Enter button.

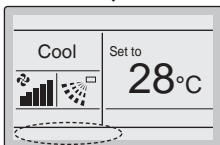
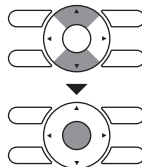

- The message shown in Step 1 will disappear from the Basic screen.



## Caution

- **Do not wash the remote controller.**  
Doing so may cause electric leakage and result in electric shocks or a fire.
  - **Be sure to stop the operation of the air conditioner and turn off the power at the time of maintenance.**  
Failure to do so may result in electric shocks or injury.
- 

## Cleaning of Remote Controller

- Wipe the surface part of the remote controller with a dry cloth when it become dirty.
- If the dirt on the surface cannot be removed, soak the cloth in neutral detergent diluted with water, squeeze the cloth tightly, and clean the surface. Wipe the surface with a dry cloth then.

### Note

- Do not use any paint thinner, organic solvent, or strong acid.



## Warning

- **Do not use flammable materials (e.g., hairspray or insecticide) near the air conditioner.**  
**Do not clean remote controller with organic solvents such as benzine or paint thinner.**  
The use of organic solvents may cause crack damage to the product, electric shocks or a fire.
-

# Reference Information

## Malfunction (Error) Code Display

### Contact Your Dealer in the Following Cases

#### Warning

- When the air conditioner is malfunctioning (e.g., giving off a burning odor), stop the air conditioner and turn off the power.

Continued operation under such circumstances may result in failure, electric shocks or a fire. Contact your local dealer.

### Operation

1

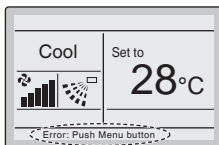

- If a malfunction occurs, either one of the following messages will appear on the Basic screen during operation.

“Error: Push Menu button.”

\* The Operation lamp will blink.

“Warning: Push Menu button.”

\* The Operation lamp will not blink.

- Press Menu/Enter button.

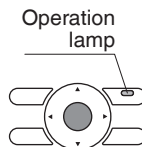

2

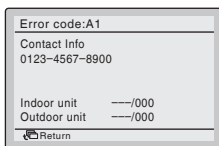

- The Error code blinks and the contact address and model name will appear.
- Notify your local dealer of the Error code and Model name.

# After-sales Service

---



## Warning

- **Do not disassemble, modify, or repair the remote controller.**  
It may cause electric shocks or a fire.  
Consult your local dealer.
  - **Do not relocate or reinstall the remote controller by yourself.**  
Improper installation may cause electric shocks or a fire.  
Consult your local dealer.
- 

## ■ Advise the Repairer of the Following Items

- |  |
|--|
| <ul style="list-style-type: none"><li>• Model name</li><li>• Date of installation</li><li>• Failure conditions: As precise as possible.</li><li>• Your address, name, and telephone number</li></ul> |
|--|

## ■ Relocation

The relocation of the remote controller requires special technology. Consult your local dealer. Actual expenses required for the relocation of the remote controller will be charged.

## ■ Inquiry about After-sales Service

Contact your local dealer.



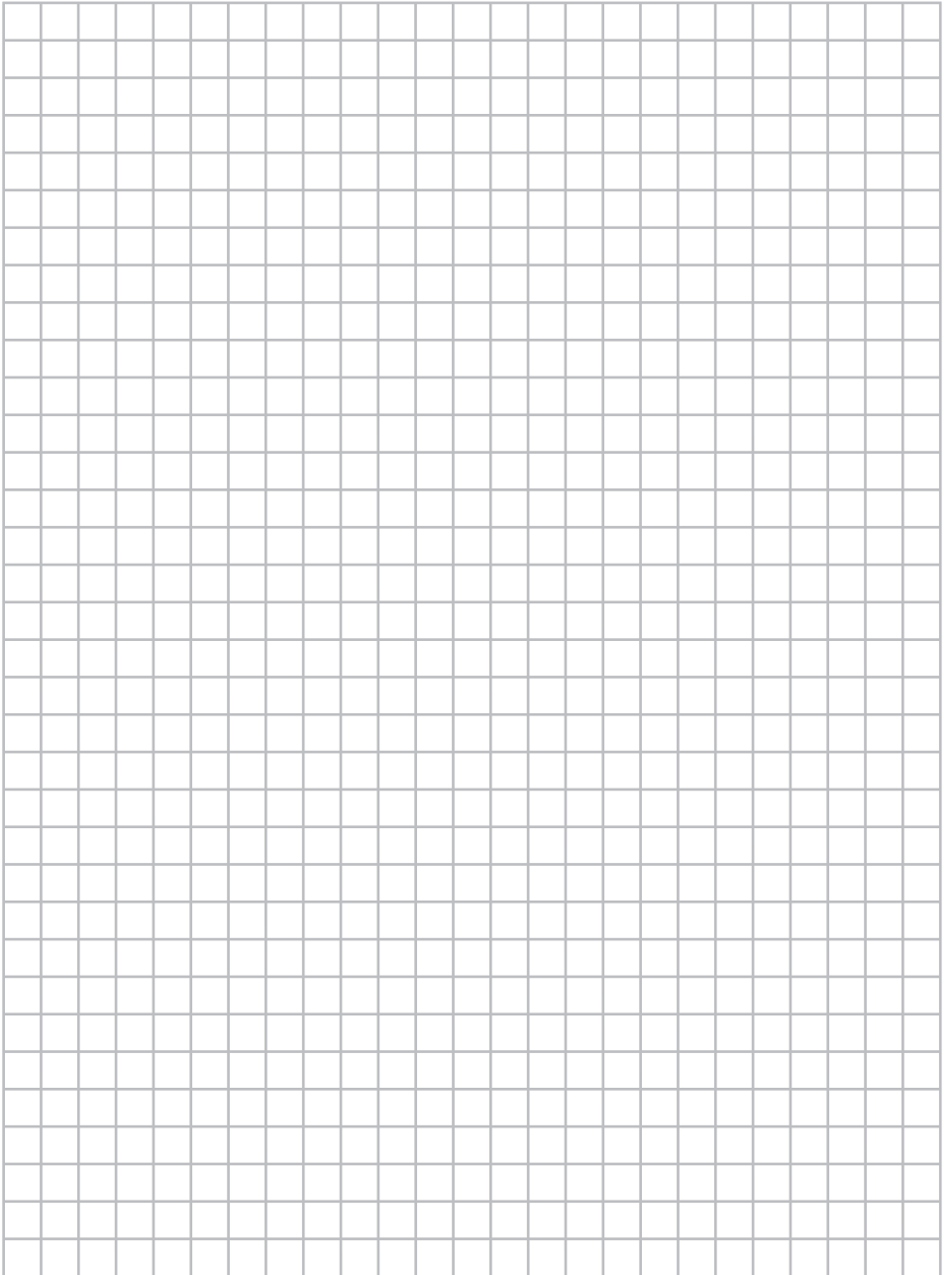



# ***DAIKIN INDUSTRIES, LTD.***

Head office:

Umeda Center Bldg., 2-4-12, Nakazaki-Nishi,  
Kita-ku, Osaka, 530-8323 Japan

Tokyo office:

JR Shinagawa East Bldg., 2-18-1, Konan,  
Minato-ku, Tokyo, 108-0075 Japan  
[http://www.daikin.com/global\\_ac/](http://www.daikin.com/global_ac/)